

*collection* \_\_\_\_\_  
**COMPLEMENTOS**



# DEKORAČNÍ KRYTY KE GARNÝŽÍM

## BARVY



00. přírodní

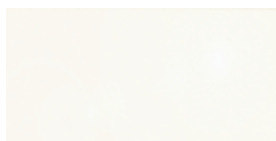

06. bílá



10. wenge



11. třešeň

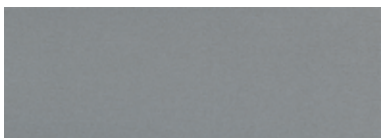

42. hliníková



70. antracit



73. uhlová

### Dekorační rám s příslušenstvím



### Dekorační kryt lepený

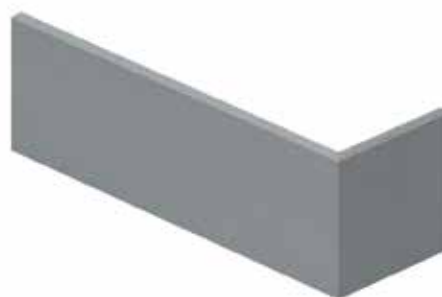

### Dekorační kryt

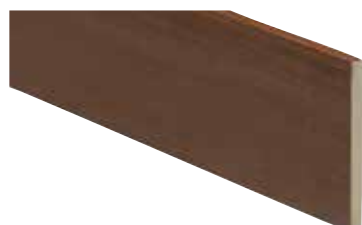

Dekorační kryt 16 X 120

REF.	Rám a míra
7007**0	524 Kč/m.

### Příslušenství

Stropní úchyt

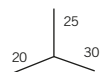

Plastové spojky pro slepení + lepidlo

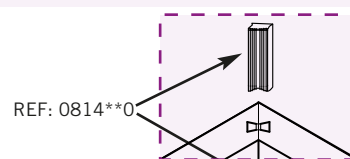
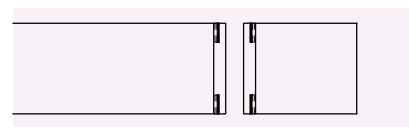
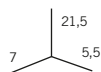

REF: 0814\*\*0

REF.	0813400	0813402	0814**0
	Balení x 2 (krabice x 25)	x 2	x 10
A	85 Kč/balení	81 Kč/bl.	99 Kč/Ks

\*\* Barvy pro rám: 00= přírodní. 06= bílá. 10= wenge. 11= třešeň. 42= hliníková. 70= antracit. 73= uhlová.

\*\* Barvy pro plastové spojky (0814\*\*0): 06= bílá. 10= wenge. 11= třešeň. 12= popelavá (barvy 70/73). 40= stříbrná (barvy 42).  
Kód obalu: 0= velikost. 2= blister.

# Dekorační rám



velikost, 16 x 120 mm.

REF.	<---->	Kč/m.
7006**0	3,60 m.	471 Kč/m.
-	Na míru	589 Kč/m.



16 x 120 mm, baleno vakuově ve folii

REF.	<---->	Kč/m.
7179**3	1,80 m.	959 Kč/Ks
7186**3	2,40 m.	1.278 Kč/Ks

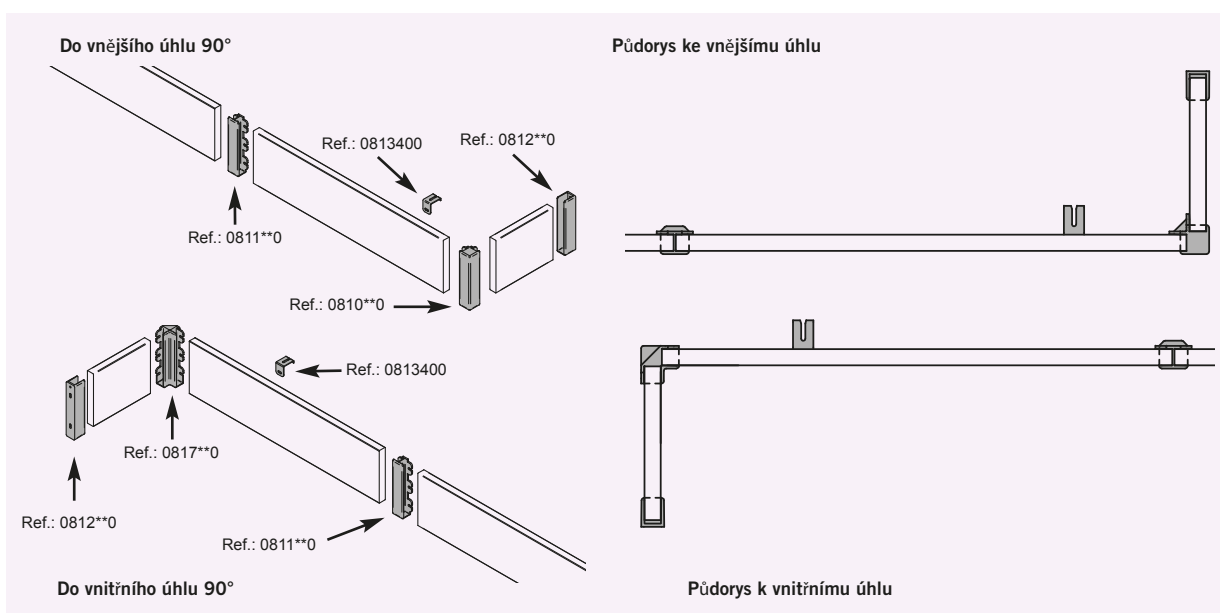

## Příslušenství

Rohová spojka, plastová (pokovovaná)

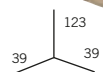

Střední spojka, plastová (pokovovaná)

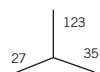

Boční koncovka, plastová (pokovovaná)

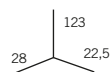

Rohová spojka, plastová (pokovovaná)



REF.	0810**0	0810**2	0811**0	0811**2	0812**0	0812**2	0817**0	0817**2
	x 6	x 1	x 10	x 1	x 10	x 1	x 6	x 1
A	106 Kč/Ks	119 Kč/bl.	128 Kč/Ks	115 Kč/bl.	118 Kč/Ks	105 Kč/bl.	111 Kč/Ks	119 Kč/bl.
B	191 Kč/Ks	217 Kč/bl.	186 Kč/Ks	214 Kč/bl.	177 Kč/Ks	205 Kč/bl.	191 Kč/Ks	217 Kč/bl.

\*\* Barvy pro rám: 00= přírodní. 06= bílá. 10= wenge. 11= třešeň. 42= hliníková. 70= antracit. 73= uhlková.  
 \*\* Barvy A: 24= zlato. 42= nikl mat. \*\* Barvy B: 43= chrom. 47= antická mosaz. 70= grafitová.  
 Kód obalu: 0= velikost. 2= blister. (Objednávkový formulář je umístěn na konci katalogu)

## Dekorační magnetické spony (k uchycení záclony)

Dekorační sponka "VENUS", oranžová



Dekorační sponka "VENUS", granátová



Dekorační sponka "VENUS", medová



REF.	4812262	4820262	4812372	4820372	4812782	4820782
	s páskou 28 cm.	se strunou 22 cm.	s páskou 28 cm.	se strunou 22 cm.	s páskou 28 cm.	se strunou 22 cm.
Kč	105 Kč/bl.	119 Kč/bl.	105 Kč/bl.	119 Kč/bl.	105 Kč/bl.	119 Kč/bl.

Dekorační sponka "VENUS", krémová



Dekorační sponka "ELIPSE", krémová



Dekorační sponka "ELIPSE", třešeň



REF.	4812792	4820792	4825792	4826792	4825852	4826852
	s páskou 28 cm.	se strunou 22 cm.	s páskou 28 cm.	se strunou 22 cm.	s páskou 28 cm.	se strunou 22 cm.
Kč	105 Kč/bl.	119 Kč/bl.	112 Kč/bl.	125 Kč/bl.	112 Kč/bl.	125 Kč/bl.

Dekorační sponka "ESTRELLA", anýz



Dekorační sponka "ESTRELLA", sobolí



Dekorační sponka "CUADRADO", čokoláda



REF.	4813802	4821802	4813812	4821812	4814772	4822772
	s páskou 28 cm.	se strunou 22 cm.	s páskou 28 cm.	se strunou 22 cm.	s páskou 28 cm.	se strunou 22 cm.
Kč	115 Kč/bl.	123 Kč/bl.	115 Kč/bl.	123 Kč/bl.	101 Kč/bl.	110 Kč/bl.

**Blister = 1 ks.**  
Kód obalu: 2= blister.



## Dekorační magnetické spony (k uchycení záclony)

Dekorační sponka "CUADRADO", citrónová



Dekorační sponka "CORAZÓN", červená



Dekorační sponka "CORAZÓN", fuchsie



REF.	<b>4814822</b>	<b>4822822</b>	<b>4823362</b>	<b>4815832</b>	<b>4823832</b>
	s páskou 28 cm.	se strunou 22 cm.	se strunou 22 cm.	s páskou 28 cm.	se strunou 22 cm.
Kč	<b>101</b> Kč/bl.	<b>110</b> Kč/bl.	<b>115</b> Kč/bl.	<b>98</b> Kč/bl.	<b>110</b> Kč/bl.

Dekorační sponka "CORAZÓN", perletová



Dekorační sponka "OVAL", granátová



Dekorační sponka "OVAL", zlatá



REF.	<b>4815842</b>	<b>4823842</b>	<b>4816372</b>	<b>4824372</b>	<b>4829372</b>	<b>4816242</b>	<b>4824242</b>	<b>4829242</b>
	s páskou 28 cm.	se strunou 22 cm.	s páskou 28 cm.	se strunou 22 cm.	se strunou 42 cm.	s páskou 28 cm.	se strunou 22 cm.	se strunou 42 cm.
Kč	<b>98</b> Kč/bl.	<b>110</b> Kč/bl.	<b>112</b> Kč/bl.	<b>125</b> Kč/bl.	<b>134</b> Kč/bl.	<b>112</b> Kč/bl.	<b>125</b> Kč/bl.	<b>134</b> Kč/bl.

Dekorační sponka "OVAL", safírová



Dekorační sponka "OVAL", nikl mat



Dekorační sponka "OVAL", chrom



REF.	<b>4816862</b>	<b>4824862</b>	<b>4829862</b>	<b>4824422</b>	<b>4829422</b>	<b>4824432</b>	<b>4829432</b>
	s páskou 28 cm.	se strunou 22 cm.	se strunou 42 cm.	se strunou 22 cm.	se strunou 42 cm.	se strunou 22 cm.	se strunou 42 cm.
Kč	<b>112</b> Kč/bl.	<b>125</b> Kč/bl.	<b>134</b> Kč/bl.	<b>149</b> Kč/bl.	<b>157</b> Kč/bl.	<b>149</b> Kč/bl.	<b>157</b> Kč/bl.

Blister = 1 ks.  
Kód obalu: 2= blister.

**Novinka**

## Dekorační magnetické spony (k uchycení záclony)

Dekorační sponka "OVAL", černý nikel



Dekorační sponka "GRANDE", zelená



Dekorační sponka "GRANDE", čokoláda



REF.	4824502	4829502	4830312	4831312	4830772	4831772
	se strunou 22 cm. se strunou 42 cm.		se strunou 22 cm. se strunou 42 cm.		se strunou 22 cm. se strunou 42 cm.	
Kč	149 Kč/bl.	157 Kč/bl.	134 Kč/bl.	138 Kč/bl.	134 Kč/bl.	138 Kč/bl.

Dekorační sponka "GRANDE", šedá



Dekorační sponka "GRANDE", nikel mat



Dekorační sponka "GRANDE", chrom



REF.	4830322	4831322	4830422	4831422	4830432	4831432
	se strunou 22 cm. se strunou 42 cm.		se strunou 22 cm. se strunou 42 cm.		se strunou 22 cm. se strunou 42 cm.	
Kč	134 Kč/bl.	138 Kč/bl.	149 Kč/bl.	157 Kč/bl.	149 Kč/bl.	157 Kč/bl.

Dekorační sponka "GRANDE", černý nikel



Dřevěný magnetický klips



Dřevěný magnetický klips s kovovou strunou



REF.	4830502	4831502	2975**5	2978**5
	se strunou 22 cm. se strunou 42 cm.		x 2	x 2
Kč	149 Kč/bl.	157 Kč/bl.	313 Kč/bal.	487 Kč/bal.

Blistr = 1 ks.

\*\* Barvy: 01= vlašský ořech. 02= borovice. 03= teak.  
Kód obalu: 2= blister. 5= malá krabice.

## Dekorační řetízky a spony

Dekorační řetízek, oranžový

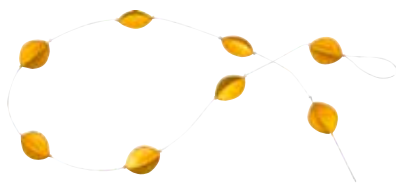

Dekorační řetízek, zelený



Dekorační řetízek, multicolor

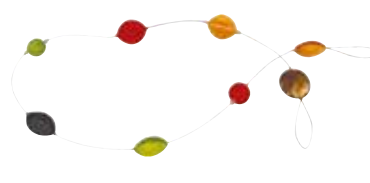

REF.	4817262	4817312	4817992
	x 1	x 1	x 1
Kč	174 Kč/bl.	174 Kč/bl.	174 Kč/bl.

Dřevěná provlékáč spona, přírodní



ø 100 mm

Dřevěná provlékáč spona, slonová kost



ø 100 mm

Dřevěná provlékáč spona, černo-stříbrná



ø 100 mm

REF.	4819003	4819333	4819733
	x 1	x 1	x 1
Kč	186 Kč/zavírací obal.	186 Kč/zavírací obal.	186 Kč/zavírací obal.

## Kovové háčky a rozety

Háček malý, hladký

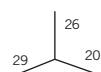

Háček velký, hladký

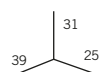

Háček hladký se šroubkem a matkou (2 kusy)

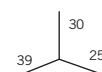

REF.	0667**0	0682**0	0682**2	1558**0
	x 10	x 10	x 2	x 10
A	26 Kč/Ks	-	-	29 Kč/Ks
B	-	28 Kč/U.	71 Kč/bl.	-

**POZNÁMKA:** položky balené v Blístru pouze do vyprodání zásob.

\*\*Barvy A: 06= bílá. 07= černá. 44= zlatá.  
Barvy B: 06= bílá. 07= černá. 43= chrom. 44= zlatá.  
Kód obalu: 0= velikost. 2= blister. 3= zavírací obal.

# Kovové háčky a rozety

Úchyt do zdi k přichycení šňůry

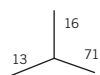

REF.	<b>1563440</b>	<b>1554440</b>	<b>1555440</b>
	x 10	x 10	x 10
44	<b>52 Kč/Ks</b>	<b>106 Kč/Ks</b>	<b>134 Kč/Ks</b>

Ozdobný úchyt ve tvaru pířka, 7 cm.

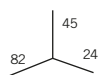

Ozdobný úchyt ve tvaru pířka, 15 cm.

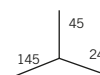

Zdobení hák na záclonu, 3 cm.

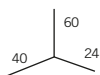

Zdobení hák na záclonu, 7 cm.

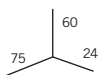

Zdobení hák na záclonu, 15 cm.

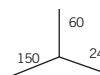

REF.	<b>1551440</b>	<b>1552440</b>	<b>1553440</b>
	x 10	x 10	x 10
44	<b>73 Kč/Ks</b>	<b>110 Kč/Ks</b>	<b>142 Kč/Ks</b>

Zdobení, zahnutý úchyt na záclonu.

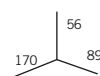

Háček zrcadlo, velký

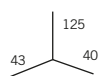

Háček zrcadlo, malý

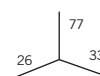

REF.	<b>0633440</b>	<b>0620440</b>	<b>0621440</b>	<b>0621442</b>
	x 5	x 10	x 10	x 2
44	<b>261 Kč/Ks</b>	<b>90 Kč/Ks</b>	<b>44 Kč/Ks</b>	<b>63 Kč/bl.</b>

**POZNÁMKA:** položky balené v Blistru pouze do vyprodání zásob.

\*\*Barvy: 44= zlatá.  
Kód obalu: 0= velikost. 2= blister.

# Kovové háčky a rozety

Háček střední



Háček malý

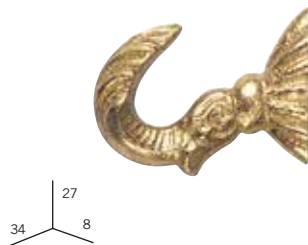

Háček srdce, velký



REF. **0602440** **0602442** **0600440** **0600442** **0645440**

x 10 x 2 x 10 x 2 x 10

44 **30 Kč/Ks** **78 Kč/bl.** **25 Kč/Ks** **66 Kč/bl.** **47 Kč/Ks**

Háček lilie



Háček ramínko

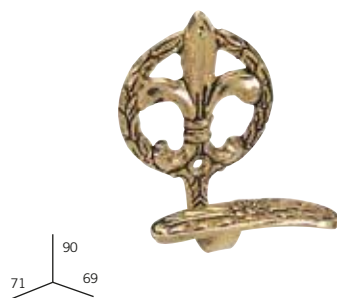

Háček mašle



REF. **0060440** **0619440** **0605440** **0605442**

x 10 x 10 x 10 x 2

44 **41 Kč/Ks** **149 Kč/Ks** **45 Kč/Ks** **125 Kč/bl.**

Háček vějíř



Háček růže



Roseta hladká, 20 cm.

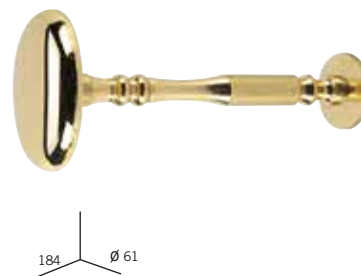

REF. **0626440** **0626442** **0607440** **0685440**

x 10 x 2 x 10 x 10

44 **50 Kč/Ks** **137 Kč/bl.** **99 Kč/Ks** **436 Kč/Ks**

**POZNÁMKA:** položky balené v Blistru pouze do vyprodání zásob.

\*\*Barvy: 44= zlatá.  
Kód obalu: 0= velikost. 2= blister.

## Kovové háčky a rozety

Roseta "Perla", 10 cm.

Roseta "Perla", 15 cm.

Roseta "Perla", 20 cm.



REF. 0686440

REF. 0687440

REF. 0688440



x 10

x 10

x 10



44

357 Kč/Ks

417 Kč/Ks

412 Kč/Ks

Roseta květina, 10 cm.

Roseta květina, 15 cm.

Roseta květina, 20 cm.



REF. 0640440

REF. 0641440

REF. 0642440



x 10

x 10

x 10



44

213 Kč/Ks

242 Kč/Ks

326 Kč/Ks

## Záclonové háčky

Ohebný háček, kovový

Ohebný háček, mosazný

Plastový háček

Plastový háček provlíkáč

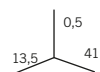
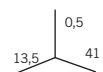

REF. 1226400 1226402

REF. 0897440

REF. 1236060

REF. 1236062

REF. 0926060

REF. 0926062

x 1000

x 25

x 1000

x 1000

x 25

x 1000

x 25



40

555 Kč/kr.

55 Kč/bl.

44

2.953 Kč/kr.



06

1.016 Kč/kr.

62 Kč/bl.

06

477 Kč/kr.

41 Kč/bl.

**POZNÁMKA:** položky balené v Blistru pouze do vyprodání zásob.

\*\*Barvy: 06= bílá, 40= stříbrná, 44= zlatá.

Kód obalu: 0= velikost, 2= blister.



# Záclonové háčky

Plastový háček provlíkáci, zpevněný



Kovový háček



Háček s očkem



REF.	1898060	0024400	0024402	0018400
	x 1000	Balení x 1000 Krabice x 10.000	x 25	Balení x 1000 Krabice x 10.000
06	597 Kč/krabice	40 336 Kč/balení	43 Kč/bl.	40 1.060 Kč/balení

Americký háček

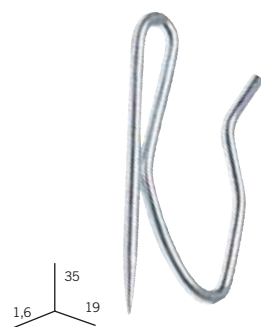

Háček jednoduchý, dlouhý

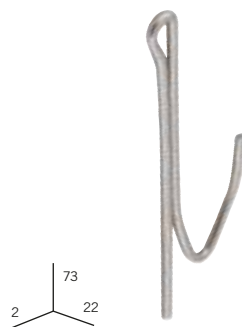

Dvoj háček

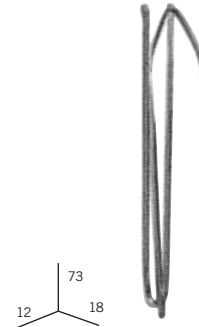

REF.	1238400	0036400	0036402	1899400
	x 1000	x 250	x 25	x 250
40	856 Kč/krabice	1.091 Kč/krabice	121 Kč/bl.	1.093 Kč/krabice

Řasící háček, krátký



Řasící háček, střední



Řasící háček, delší



Řasící háček, dlouhý



REF.	0027400	0027402	1208400	0026400	0026402	0423400
	Balení x 100 Krabice x 1.000	x 10	Balení x 100 Krabice x 1.000	Balení x 100 Krabice x 1.000	x 10	Balení x 100 Krabice x 1.000
40	533 Kč/balení	108 Kč/bl.	552 Kč/balení	552 Kč/balení	111 Kč/bl.	566 Kč/balení

**POZNÁMKA:** položky balené v Blistru pouze do vyprodání zásob.

\*\*Barvy: 06= bílá. 40= stříbrná.  
Kód obalu: 0= velikost. 2= blister.

# Automatické řasící pásy

Automatická řasící páska 30  
VZOR: 2 x 1 / SKLADY: 1



Automatická řasící páska 55  
VZOR: 2 x 1 / SKLADY: 2



Automatická řasící páska 65D  
VZOR: 2 x 1 / SKLADY: 2



REF.	0261**1	0261**2	0550**1	0220**1	0220**2
	x 100 m.	x 6 m.	x 100 m.	x 100 m.	x 6 m.
06	17 Kč/m.	146 Kč/bl.	19 Kč/m.	20 Kč/m.	162 Kč/bl.
20	-	-	-	29 Kč/m.	201 Kč/bl.
21	17 Kč/m.	149 Kč/bl.	19 Kč/m.	21 Kč/m.	165 Kč/bl.

Automatická řasící páska 70/5  
VZOR: 2 x 1 / SKLADY: 5



Automatická řasící páska 75/5 LUXE  
VZOR: 2 x 1 / SKLADY: 5



Automatická řasící páska 75/6 INV.  
VZOR: 2 x 1 / SKLADY: 6

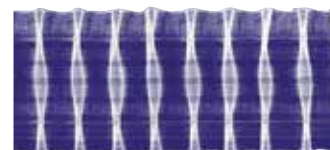

REF.	1661**1	0524**1	0216201
	x 100 m.	x 100 m.	x 100 m.
06	22 Kč/m.	30 Kč/m.	20 42 Kč/m.
21	22 Kč/m.	37 Kč/m.	-

Automatická řasící páska 85/6  
VZOR: 2 x 1 / SKLADY: 6



Multifunkční řasící páska 100  
VZOR: 2 x 1 / SKLADY: 1

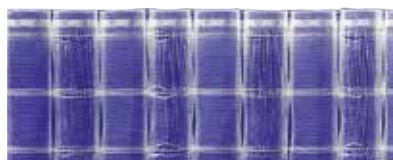

Hexanyl 85  
VZOR: 2,2 x 1 / SKLADY: 3



REF.	0222**1	0218201	0234**1
	x 100 m.	x 100 m.	x 100 m.
06	28 Kč/m.	20 63 Kč/m.	06 29 Kč/m.
21	29 Kč/m.		21 30 Kč/m.

**POZNÁMKA:** položky balené v Blístru pouze do vyprodání zásob.

\*\*Barvy: 06= bílá, 20= průhledná, 21= béžová.  
Kód obalu: 1= krabice, 2= blister.

## Automatické řasící pásky

Páska "NIDO DE ABEJA" 85  
VZOR: 2,2 x 1 / SKLADY: 2



Páska "GLOBO" 100  
VZOR: 2 x 1 / SKLADY: 4



**Novinka**



Páska "TRIPLEC" 75/3  
VZOR: 2 x 1 / SKLADY: 3

**Novinka**



REF.	0231**1	0236**1	0179**1
	x 100 m.	x 100 m.	x 100 m.
	06 <b>28</b> Kč/m.	42 Kč/m.	33 Kč/m.
	21 <b>29</b> Kč/m.	42 Kč/m.	33 Kč/m.

Páska "TRIPLEC" 120/5  
VZOR: 2,3 x 1 / SKLADY: 5

**Novinka**





Tablas 75/5-250  
VZOR: 2,5 x 1 / SKLADY: 5





Tablas 75/5-200  
VZOR: 2 x 1 / SKLADY: 5



REF.	0225**1	0465**1	1651**1
	x 100 m.	x 100 m.	x 100 m.
	06 <b>52</b> Kč/m.	28 Kč/m.	28 Kč/m.
	21 <b>53</b> Kč/m.	28 Kč/m.	28 Kč/m.

Tablas 75/6-200  
VZOR: 2 x 1 / SKLADY: 6



REF.	0219201
	x 100 m.
	20 <b>58</b> Kč/m.

**POZNÁMKA:** položky balené v Blistru pouze do vyprodání zásob.

\*\*Barvy: **06**= bílá. **20**= průhledná. **21**= béžová.  
Kód obalu: **1**= krabice.

# CORTITEX

Cortitex 70/3.  
SKLADY: 3



Cortitex 70/6.  
SKLADY: 6



Cortitex 75/6, průhledná.  
SKLADY: 6



Cortitex 75/2, průhledná.  
SKLADY: 2

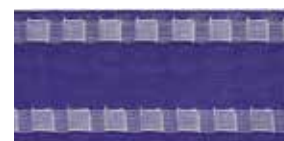

**Novinka**

REF.	1663061	0158061	0217201	0256201	0256204
	x 100 m.	x 100 m.	x 100 m.	x 100 m.	Metráž.
06	22 Kč/m.	47 Kč/m.	-	-	-
20	-	-	51 Kč/m.	45 Kč/m.	54 Kč/m.

# PÁSKY NA TYČE

Crestanyl 90.  
SKLADY: 1



E-Automatická páska 65  
VZOR: 2 x 1 / SKLADY: 2



E-Automatická páska 85  
VZOR: 2 x 1 / SKLADY: 2



Velká řasící páska 90  
SKLADY: 1



REF.	0054**1	0228**1	0229**1	0243**1
	x 100 m.	x 100 m.	x 100 m.	x 100 m.
06	22 Kč/m.	28 Kč/m.	32 Kč/m.	22 Kč/m.
21	22 Kč/m.	28 Kč/m.	34 Kč/m.	22 Kč/m.

# Volné řasení

LIA 35  
VZOR: volný / SKLADY: 1



LIA 55  
VZOR: volný / SKLADY: 2



LIA 75  
VZOR: volný / SKLADY: 2



F-LIBRE 70/4  
VZOR: volný / SKLADY: 4



REF.	0253**1	0254**1	0255**1	0255**2	0055201
	x 100 m.	x 100 m.	x 100 m.	x 4 m.	x 100 m.
06	18 Kč/m.	24 Kč/m.	26 Kč/m.	149 Kč/bl.	28 Kč/m.
21	18 Kč/m.	24 Kč/m.	26 Kč/m.	152 Kč/bl.	

**POZNÁMKA:** položky balené v Blistru pouze do vyprodání zásob.

\*\*Barvy: 06= bílá, 20= průhledná, 21= béžová.  
Kód obalu: 1= krabice, 2= blister.



# LOOP (se semišovou stuhou)

F-Automatická 40 Loop  
VZOR: 2 x 1 / SKLADY: -

F-Automatická 65 Loop  
VZOR: 2 x 1 / SKLADY: 1

Tabulková 40 Loop  
VZOR: 2,3 x 1 / SKLADY: -

Tabulková 75-230 Loop  
VZOR: 2,3 x 1 / SKLADY: 3



REF.	1656061	1655061	1654061	1653061
	x 100 m.	x 100 m.	x 100 m.	x 100 m.
 06	29 Kč/m.	37 Kč/m.	29 Kč/m.	47 Kč/m.

## Záclony a rolety

Páska s tunelem (k obšití)

Páska hladká

Hladká šňůrka k navíjení



REF.	0053**0	0037**0	1662**0
	Návin x 300 m.	Návin x 200 m.	Návin x 200 m.
 06	9 Kč/m.	15 Kč/m.	7 Kč/m.
20	16 Kč/m.	15 Kč/m.	9 Kč/m.
21	9 Kč/m.	15 Kč/m.	-

Páska s tunelem (k sešití)

Páska s vlascem

Páska s kroužky

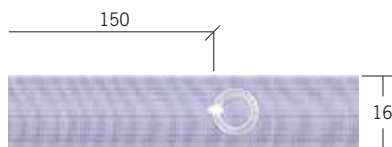

REF.	0104**0	0031200	0032200
	Návin x 300 m.	Návin x 200 m.	Návin x 150 m.
 06	22 Kč/m.	-	-
20	22 Kč/m.	20 Kč/m.	46 Kč/m.
21	22 Kč/m.	-	-

\*\*Barvy: 06= bílá. 20= průhledná. 21= béžová.  
Kód obalu: 0= velikost. 1= krabice.

## Výztuhové řasící pásky

Výztuhová řasící páska 70



Výztuhová řasící páska 90



Výztuhová řasící páska 100, s otvorem pro tyč



Výztuhová řasící páska 100 děrovaná pro kroužky



Novinka

Novinka

REF.	1657**1	0505**1	0526201	0213201
	x 100 m.	x 100 m.	x 100 m.	x 100 m.
06	18 Kč/m.	19 Kč/m.	-	-
20	-	22 Kč/m.	38 Kč/m.	41 Kč/m.
21	19 Kč/m.	19 Kč/m.	-	-

## Pásky s otvorem pro kroužek

Páska "CHY-CORT" 6-P s otvory pro kroužek Ø 16



Páska 85 s otvory pro kroužek Ø 42



Novinka

REF.	0155**1	0153061
	x 50 m.	x 50 m.
06	69 Kč/m.	101 Kč/m.
21	69 Kč/m.	-

## Řetízek a tavící páska

Sežehlovací lepicí páska (k slepení látky)

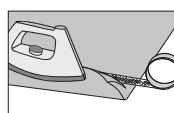
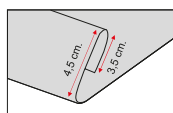

Řetízek 50 gr.



REF.	0156201	0145060
	x 100 m.	Návin x 50 m.
06	-	30 Kč/m.
20	10 Kč/m.	-

\*\*Barvy: 06= bílá, 20= průhledná, 21= béžová.  
Kód obalu: 0= velikost, 1= krabice.



## Suché zipy

Suchý zip s vyšším chlupem (1)



Suchý zip s vyšším chlupem



Suchý zip s vyšším chlupem - lepicí



REF.	0991**0	0857060	1520**0
	Návin x 25 m.	Návin x 25 m.	Návin x 25 m.
06	19 Kč/m.	38 Kč/m.	29 Kč/m.
07	19 Kč/m.	-	29 Kč/m.
32	18 Kč/m.	-	-

Suchý zip klasik (1)



Suchý zip klasik - lepicí



Suchý zip pro zachycení (s háčky)



REF.	1698060	0840060	1510**0
	Návin x 25 m. Minimální objednávka 250 m.	Návin x 25 m.	Návin x 25 m.
06	13 Kč/m.	70 Kč/m.	22 Kč/m.
07	-	-	21 Kč/m.

Suchý zip pro zachycení (s háčky) - lepicí



Suchý zip pro zachycení (s háčky) - lepicí

Párovaný suchý zip,  
ze záchytné části lepicí

Novinka

REF.	0742060	0893**0	2560062
	Návin x 25 m.	Návin x 25 m.	 x 4 m.
06	84 Kč/m.	31 Kč/m.	259 Kč/bl.
07	-	31 Kč/m.	-
32	-	32 Kč/m.	-

(1): Páska **Loop** je pro kombinaci s páskou **Hook**. Páska **Velur** je pro kombinaci s páskou **Setax**. Všechny profily Chyc jsou s lepším povrchem a jdou s páskou **Hook**. Páska **Velur** se může dát dohromady s páskou **Hook**, ale páska **Loop** se nemůže kombinovat s páskou **Setax**.

**POZNÁMKA:** položky balené v Blistru pouze do vyprodání zásob.



\*\*Barvy: 06= bílá. 07= černá. 32= šedá.

Kód obalu: 0= velikost. 2= krabice.

## Popotahovací tyč Zirconio

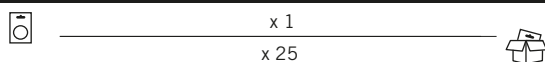

Popotahovací tyč 1,00 m., s karabinou

REF. **4599\*\*2**

 42  
A

381 Kč/bl.

404 Kč/bl.

## Popotahovací tyče kované



Popotahovací tyč 0,75 m., s karabinou

Popotahovací tyč 1,00 m., s karabinou



REF.

**4036\*\*5****4036\*\*2****4037\*\*5****4037\*\*2**

x 30

x 30

x 30

x 30

 07  
B  
C  
D

380 Kč/balení

400 Kč/balení

420 Kč/balení

437 Kč/balení

415 Kč/bl.

442 Kč/bl.

463 Kč/bl.

483 Kč/bl.

390 Kč/balení

410 Kč/balení

428 Kč/balení

447 Kč/balení

428 Kč/bl.

454 Kč/bl.

476 Kč/bl.

496 Kč/bl.

Popotahovací tyč 0,75 m.,  
s ozdobnou rukojetí a karabinouPopotahovací tyč 1,00 m.,  
s ozdobnou rukojetí a karabinou

REF.

**4043\*\*5****4044\*\*5**

x 1

x 1

x 30

x 30



 07  
B  
C  
D

454 Kč/balení

475 Kč/balení

499 Kč/balení

515 Kč/balení

462 Kč/balení

483 Kč/balení

509 Kč/balení

534 Kč/balení

\*\* Barvy: 07= černá. 42= nikl mat.

\*\* Barvy A: 43= chrom. 44= zlatá. 46= matná zlatá. 47= antická mosaz.

\*\* Barvy B: 60= perlová. 61= černo-zelená. 63= hnědo-měděná. 69= černo-zlatá. 72= černo-měděná. 73= černo-stříbrná.

\*\* Barvy C: 06= bílá. 62= slonová kost-zlatá. 74= zeleno-zlatá. 75= červeno-zlatá

\*\* Barvy D: 65= modro-bílá. 66= zlato-žlutá. 68= lososovo-zlatá. 76= jíl.

Kód obalu: 2= blister. 5= malá krabice.

## Popotahovací tyč dřevěná



Popotahovací tyč 0,75 m., s karabinou

Popotahovací tyč 1,00 m., s karabinou

REF.	0198**0	0698**0	0698**2
	 x 35	 x 35	 x 1
 A	84 Kč/Ks	94 Kč/Ks	133 Kč/bl.
B	93 Kč/Ks	103 Kč/Ks	146 Kč/bl.



Popotahovací tyč 0,75 m., s háčkem

Popotahovací tyč 1,00 m., s háčkem

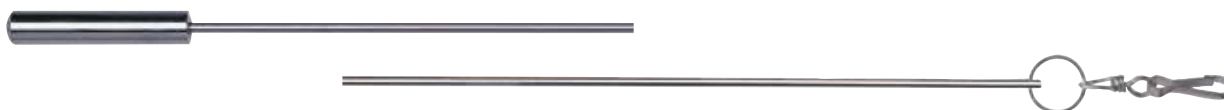

REF.	0543**0	0284**0
	 x 35	x 35
 A	86 Kč/Ks	95 Kč/Ks
B	94 Kč/Ks	104 Kč/Ks

## Popotahovací tyč Chy-Cort



Popotahovací tyč 1,00 m.



Popotahovací tyč 1,00 m.

REF.	0555430	0555432
	 x 100	 x 2
 43	241 Kč/Ks	579 Kč/bl.



Popotahovací tyč s pevným okem 1,00 m.

Popotahovací tyč s pevným okem 1,00 m.

REF.	0285430	0285432
	 x 50	 x 2
 43	266 Kč/Ks	579 Kč/bl.

\*\* Barvy: 43= chrom.

\*\* 01= vlašský ořech. 02= borovice. 03= teak. 04= dub. 05= kaštanová. 09= mahagon. 10= wenge. / \*\* Barvy B: 06= bílá. 07= černá. 79= krémová.  
Kód obalu: 0= velikost. 2= blister.

## Popotahovací tyče metakrylát

Popotahovací tyč Ø12 mm x 0,75 m. Zkosený typ. Metakrylát.



REF. **7217200**



x 25



20

**330 Kč/Ks**

Popotahovací tyč Ø12 mm x 0,75 m. S rukojetí. Metakrylát.



REF. **7232200**



x 25



20

**497 Kč/Ks**

Popotahovací tyč Ø15 mm x 0,75 m. Zkosený typ. Metakrylát.



REF. **7227200**



x 25



20

**426 Kč/Ks**



Popotahovací tyč Ø15 mm x 0,75 m. Osmiuhelníková. Kulatý typ. Metakrylát.

REF. **7233200**



x 25





20

**489 Kč/Ks**

## Popotahovací tyč, laminovaná



	0,75 m.	1,00 m.	1,25 m.	1,50 m.
REF.	<b>0847**0</b>	<b>0992**0</b>	<b>0998060</b>	<b>0946060</b>
	x 25	x 25	x 25	x 25
	06	07	06	07
	<b>50 Kč/Ks</b>	<b>53 Kč/Ks</b>	<b>64 Kč/Ks</b>	<b>78 Kč/Ks</b>
	<b>52 Kč/Ks</b>	<b>55 Kč/Ks</b>	-	-

\*\*Barvy: **06**= bílá. **07**= černá. **20**= průhledná.  
Kód obalu: **0**= velikost.

## Příslušenství ke schodištím (mosaz)

Mosazná tyč na schodiště Ø16



REF.	←----→			44	49
4796**0	3,00 m.	x 1		1.960 Kč/Ks	2.145 Kč/Ks

## Příslušenství

Mosazná upínací koule



Plochá mosazná upínací koule



REF.	4770**4	4771**4
	x 10	x 10
	44 186 Kč/Ks	186 Kč/Ks
	49 200 Kč/Ks	200 Kč/Ks

Mosazný kloubový držák



Mosazný pevný držák



REF.	4772**4	4773**4
	x 10	x 10
	44 481 Kč/Ks	222 Kč/Ks
	49 525 Kč/Ks	242 Kč/Ks

\*\* Barvy: 44= zlatá, 49= nerez.  
Kód obalu: 0= velikost, 4= ochranný obal.

## Kovové záclonové kroužky

Kovový kroužek, staroměděný.



Ø Int. 40  
Ø Ext. 60

Kovový kroužek, matný nikl.



Ø Int. 40  
Ø Ext. 60

Kovový kroužek, antická mosaz.



Ø Int. 40  
Ø Ext. 60

REF.	0044410	0044420	0044470
	x 100	x 100	x 100
41	21 Kč/Ks	42	21 Kč/Ks
47			21 Kč/Ks

Kovový kroužek, nerez.



Ø Int. 40  
Ø Ext. 60

Výstelka do kroužků



Ø int. 38  
5

REF.	0044490	0051**0
	x 100	x 100
49	21 Kč/Ks	07
		20
		5 Kč/Ks
		5 Kč/Ks

Základní systém pro umístění kroužku



Ruční stroj s pákou a podložkou pro umístění kroužků



REF.	7476000
Čisté náklady	4.350 Kč/Ks
	Kontaktujte obchodní oddělení

\*\* Barvy: 07= černá. 20= průhledná. 41= stará měď. 42= nikl mat. 47= antická mosaz. 49= nerez.  
Kód obalu: 0= velikost.



# Plastové záclonové kroužky (snadná montáž)

Ozdobný kroužek čtvercový



Ø Int. 43  
Ø Ext. 71

Ozdobný kroužek kulatý (žebrovany)



Ø Int. 43  
Ø Ext. 71

REF.	0191**0	0191430	0191**2	0191432	0194**0	0194**2
	x 32	x 32	Blister x 8 10 Blister/ Kabrice		x 32	Blister x 8 10 Blister/ Kabrice
A	31 Kč/Ks	78 Kč/Ks	279 Kč/bl.	628 Kč/bl.	-	-
B	-	-	-	-	31 Kč/Ks	279 Kč/bl.

Ozdobný kroužek kulatý (hladký)



Ø Int. 43  
Ø Ext. 71

Ozdobný kroužek oválný, matný niki



Ø Int. 43  
Ø Ext. 81

Ozdobný kroužek oválný transparentní, antická mosaz



Ø Int. 43  
Ø Ext. 81

REF.	0196**0	0196**2	0193420	0193422	0195470	0195472
	x 32	Blister x 8 10 Blister/ Kabrice	x 32	Blister x 8 10 Blister/ Kabrice	x 32	Blister x 8 10 Blister/ Kabrice
42	57 Kč/Ks	515 Kč/bl.	84 Kč/Ks	665 Kč/bl.	-	-
43	66 Kč/Ks	555 Kč/bl.	-	-	-	-
47	-	-	-	-	45 Kč/Ks	362 Kč/bl.

Ozdobný kroužek oválný



Ø Int. 43  
Ø Ext. 81

Výztuhová řasící páska 100 děrovaná pro kroužky



REF.	0192**0	0192**2	0213201
	x 32	Blister x 8 10 Blister/ Kabrice	x 100 m.
43 - 47	84 Kč/Ks	665 Kč/bl.	20 41 Kč/m.

\*\* Barvy: 20= průhledná. 42= niki mat. 43= chrom. 47= antická mosaz.  
\*\* Barvy A: 06= bílá. 07= černá. 26= oranžová. 31= zelená. 43= chrom. 83= fuchsie.  
\*\* Barvy B: 07= černá. 32= šedá. 44= zlatá. 47= antická mosaz.  
Kód obalu: 1= krabice. 2= blister.

# ROZKLÁDACÍ HLINÍKOVÉ ŽEBŘÍKY "CHYC"

Žebřík 3 schodový

Žebřík 4 schodový

Žebřík 5 schodový

Žebřík 6 schodový  
(s bezpečnostním popruhem)



REF.	3001403	3002403	3003403	3004403
	x 1	x 1	x 1	x 1
	2.196 Kč/Ks	2.585 Kč/Ks	2.988 Kč/Ks	3.898 Kč/Ks



Decr. N° 96-333

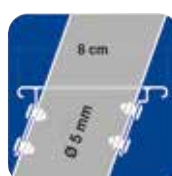
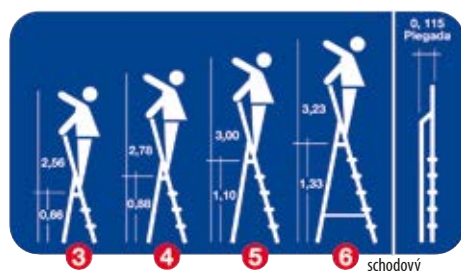

Na každý schod 8 ocelových nýtů o Ø5 mm.



Vysoká pevnost spoje, ocelový spoj, o Ø 6 mm.



Hliníková trubka je o síle 1,20 mm.



Se zaoblenými hranami v oblasti platformy.

# FABRICACIÓN

*a medida*



## Zaslepený profil 7347, Se šňůrou a rychlým snížením



Výška až do 1,80 m.

<---->	Reference	Kompletní	s tyčkami a bez pásky	bez tyček a pásky
Až do 0,60m.	9033060	-	-	-
0,61-0,70 m.	9033070	-	-	-
0,71-0,80 m.	9033080	-	-	-
0,81-0,90 m.	9033090	-	-	-
0,91-1,00 m.	9033100	-	-	-
1,01-1,10 m.	9033110	-	-	-
1,11-1,20 m.	9033120	-	-	-
1,21-1,30 m.	9033130	-	-	-
1,31-1,40 m.	9033140	-	-	-
1,41-1,50 m.	9033150	-	-	-
1,51-1,60 m.	9033160	-	-	-
1,61-1,70 m.	9033170	-	-	-
1,71-1,80 m.	9033180	-	-	-
1,81-1,90 m.	9033190	-	-	-
1,91-2,00 m.	9033200	-	-	-
2,01-2,10 m.	9033210	-	-	-
2,11-2,20 m.	9033220	-	-	-
2,21-2,30 m.	9033230	-	-	-
2,31-2,40 m.	9033240	-	-	-
2,41-2,50 m.	9033250	-	-	-
2,51-2,60 m.	9033260	-	-	-
2,61-2,70 m.	9033270	-	-	-
2,71-2,80 m.	9033280	-	-	-
2,81-2,90 m.	9033290	-	-	-
2,91-3,00 m.	9033300	-	-	-

Výška až do 3,00 m.

<---->	Reference	Kompletní	s tyčkami a bez pásky	bez tyček a pásky	Reference	svíslá páska s vlascem
Až do 0,60m.	9034060	-	-	-	9064060	-
0,61-0,70 m.	9034070	-	-	-	9064070	-
0,71-0,80 m.	9034080	-	-	-	9064080	-
0,81-0,90 m.	9034090	-	-	-	9064090	-
0,91-1,00 m.	9034100	-	-	-	9064100	-
1,01-1,10 m.	9034110	-	-	-	9064110	-
1,11-1,20 m.	9034120	-	-	-	9064120	-
1,21-1,30 m.	9034130	-	-	-	9064130	-
1,31-1,40 m.	9034140	-	-	-	9064140	-
1,41-1,50 m.	9034150	-	-	-	9064150	-
1,51-1,60 m.	9034160	-	-	-	9064160	-
1,61-1,70 m.	9034170	-	-	-	9064170	-
1,71-1,80 m.	9034180	-	-	-	9064180	-
1,81-1,90 m.	9034190	-	-	-	9064190	-
1,91-2,00 m.	9034200	-	-	-	9064200	-
2,01-2,10 m.	9034210	-	-	-	9064210	-
2,11-2,20 m.	9034220	-	-	-	9064220	-
2,21-2,30 m.	9034230	-	-	-	9064230	-
2,31-2,40 m.	9034240	-	-	-	9064240	-
2,41-2,50 m.	9034250	-	-	-	9063250	-
2,51-2,60 m.	9034260	-	-	-	9064260	-
2,61-2,70 m.	9034270	-	-	-	9064270	-
2,71-2,80 m.	9034280	-	-	-	9064280	-
2,81-2,90 m.	9034290	-	-	-	9064290	-
2,91-3,00 m.	9034300	-	-	-	9064300	-

### PŘÍSLUŠENSTVÍ:

**Kompletní:** Hliníkový profil, páska pro řasení, suchý zip, navijecí kabel, malá brzda řetězu, hliníková hřídel, zátěžová lišta, polyesterové tyče, koncové kroužky, úchyty, koncovka k zachycení pásky, koncovky k zátěžové liště, koncovky k profilu, šrouby, hmoždinky a návod.

**S tyčkami a bez pásky:** Hliníkový profil, navijecí kabel, malá brzda řetězu, hliníková hřídel, zátěžová lišta, polyesterové tyče, koncové kroužky, úchyty, koncovka k zachycení pásky, koncovky k zátěžové liště, koncovky k profilu, koncovky k tyči, šrouby, hmoždinky a návod.

**Bez tyček a bez pásky:** Hliníkový profil, navijecí kabel, malá brzda řetězu, hliníková hřídel, zátěžová lišta, koncové kroužky, úchyty, koncovka k zachycení pásky, koncovky k zátěžové liště, koncovky k profilu, šrouby, hmoždinky a návod..

**Svíslá páska s vlascem:** Hliníkový profil, suchý zip, svíslá páska s vlascem, navijecí kabel, malá brzda řetězu, hliníková hřídel, kroužky, zátěžová lišta, koncové kroužky, úchyty, koncovka k zachycení pásky, koncovky k zátěžové liště, koncovky k profilu, šrouby, hmoždinky a návod.

### PŘÍSLUŠENSTVÍ: "STANDARDNÍ"

**Komponenty, které Riel Chyc používá při měření:**

-Vodiče a držáky: 1,20 m. (2), mezi 1,21 a 2,10 (3), přes 2,10 m. (4)

-Polyesterová tyč Ø4 mm. a koncovky: každých 30 cm.

Dodatečné nebo jiné komponenty budou účtovány dle ceníku. Zátěžové lišty a polyesterové tyče jsou standardně řezány 3 cm. na výšku nepožaduje-li zákazník jinak.

# Římská roleta se sníženým profilem 864, se šňůrou a rychlým snížením



Výška až do 1,80 m.

<---->	Reference	Kompletní	s tyčkami a bez pásy	bez tyček a pásy	Reference	svislá páska s vlascem
Až do 0,60m.	9035060	-	-	-	9065060	-
0,61-0,70 m.	9035070	-	-	-	9065070	-
0,71-0,80 m.	9035080	-	-	-	9065080	-
0,81-0,90 m.	9035090	-	-	-	9065090	-
0,91-1,00 m.	9035100	-	-	-	9065100	-
1,01-1,10 m.	9035110	-	-	-	9065110	-
1,11-1,20 m.	9035120	-	-	-	9065120	-
1,21-1,30 m.	9035130	-	-	-	9065130	-
1,31-1,40 m.	9035140	-	-	-	9065140	-
1,41-1,50 m.	9035150	-	-	-	9065150	-
1,51-1,60 m.	9035160	-	-	-	9065160	-
1,61-1,70 m.	9035170	-	-	-	9065170	-
1,71-1,80 m.	9035180	-	-	-	9065180	-
1,81-1,90 m.	9035190	-	-	-	9065190	-
1,91-2,00 m.	9035200	-	-	-	9065200	-
2,01-2,10 m.	9035210	-	-	-	9065210	-
2,11-2,20 m.	9035220	-	-	-	9065220	-
2,21-2,30 m.	9035230	-	-	-	9065230	-
2,31-2,40 m.	9035240	-	-	-	9065240	-
2,41-2,50 m.	9035250	-	-	-	9065250	-
2,51-2,60 m.	9035260	-	-	-	9065260	-
2,61-2,70 m.	9035270	-	-	-	9065270	-
2,71-2,80 m.	9035280	-	-	-	9065280	-
2,81-2,90 m.	9035290	-	-	-	9065290	-
2,91-3,00 m.	9035300	-	-	-	9065300	-

Výška až do 3,00 m.

<---->	Reference	Kompletní	s tyčkami a bez pásy	bez tyček a pásy	Reference	svislá páska s vlascem
Až do 0,60m.	9036060	-	-	-	9066060	-
0,61-0,70 m.	9036070	-	-	-	9066070	-
0,71-0,80 m.	9036080	-	-	-	9066080	-
0,81-0,90 m.	9036090	-	-	-	9066090	-
0,91-1,00 m.	9036100	-	-	-	9066100	-
1,01-1,10 m.	9036110	-	-	-	9066110	-
1,11-1,20 m.	9036120	-	-	-	9066120	-
1,21-1,30 m.	9036130	-	-	-	9066130	-
1,31-1,40 m.	9036140	-	-	-	9066140	-
1,41-1,50 m.	9036150	-	-	-	9066150	-
1,51-1,60 m.	9036160	-	-	-	9066160	-
1,61-1,70 m.	9036170	-	-	-	9066170	-
1,71-1,80 m.	9036180	-	-	-	9066180	-
1,81-1,90 m.	9036190	-	-	-	9066190	-
1,91-2,00 m.	9036200	-	-	-	9066200	-
2,01-2,10 m.	9036210	-	-	-	9066210	-
2,11-2,20 m.	9036220	-	-	-	9066220	-
2,21-2,30 m.	9036230	-	-	-	9066230	-
2,31-2,40 m.	9036240	-	-	-	9066240	-
2,41-2,50 m.	9036250	-	-	-	9066250	-
2,51-2,60 m.	9036260	-	-	-	9066260	-
2,61-2,70 m.	9036270	-	-	-	9066270	-
2,71-2,80 m.	9036280	-	-	-	9066280	-
2,81-2,90 m.	9036290	-	-	-	9066290	-
2,91-3,00 m.	9036300	-	-	-	9066300	-

## PŘÍSLUŠENSTVÍ

**Kompletní:** Hliníkový profil, suchý zip, navijecí systém s plochou šňůrkou, malá brzda řetězu, hliníková hřídel, zátěžová lišta, polyesterové tyče, páska pro řasení, koncové kroužky, úchyty, koncovka k zachycení pásy, koncovky k tyči, koncovky k zátěžové liště, koncovky k profilu, šrouby, hmoždinky, imbusový klíč a návod.

**S tyčkami a bez pásy:** Hliníkový profil, navijecí systém s plochou šňůrkou, malá brzda řetězu, hliníková hřídel, zátěžová lišta, polyesterové tyče, koncové kroužky, úchyty, koncovka k zachycení pásy, koncovky k zátěžové liště, koncovky k profilu, koncovky k tyči, šrouby, hmoždinky, imbusový klíč a návod.

**Bez tyček a bez pásy:** Hliníkový profil, navijecí systém s plochou šňůrkou, malá brzda řetězu, hliníková hřídel, zátěžová lišta, koncové kroužky, úchyty, koncovka k zachycení pásy, koncovky k zátěžové liště, koncovky k profilu, šrouby, hmoždinky, imbusový klíč a návod.

**Svislá páska s vlascem:** Hliníkový profil, suchý zip, navijecí systém s plochou šňůrkou, malá brzda řetězu, hliníková hřídel, zátěžová lišta, koncové kroužky, svislá páska s vlascem, úchyty, koncovka k zachycení pásy, koncovky k zátěžové liště, koncovky k profilu, šrouby, hmoždinky, imbusový klíč a návod.

## PŘÍSLUŠENSTVÍ: "STANDARDNÍ"

Komponenty, které Riel Chyc používá při měření:

-Vodiče a držáky: 1.20 m. (2), mezi 1,21 a 2,10 (3), přes 2,10 m. (4)

-Polyesterová tyč Ø4 mm. a koncovky: každých 30 cm.

Dodatečné nebo jiné komponenty budou účtovány dle ceníku. Zátěžové lišty a polyesterové tyče jsou standardně řezány 3 cm. na výšku nepožaduje-li zákazník jinak.



# Římská roleta s profilem 7206, řetízek



Výška až do 1,80 m.

<---->	Reference	Kompletní	s tyčkami a bez pásky	bez tyček a pásky	Reference	svislá páska s vlascem
Až do 0,60m.	9037060	-	-	-	9067060	-
0,61-0,70 m.	9037070	-	-	-	9067070	-
0,71-0,80 m.	9037080	-	-	-	9067080	-
0,81-0,90 m.	9037090	-	-	-	9067090	-
0,91-1,00 m.	9037100	-	-	-	9067100	-
1,01-1,10 m.	9037110	-	-	-	9067110	-
1,11-1,20 m.	9037120	-	-	-	9067120	-
1,21-1,30 m.	9037130	-	-	-	9067130	-
1,31-1,40 m.	9037140	-	-	-	9067140	-
1,41-1,50 m.	9037150	-	-	-	9067150	-
1,51-1,60 m.	9037160	-	-	-	9067160	-
1,61-1,70 m.	9037170	-	-	-	9067170	-
1,71-1,80 m.	9037180	-	-	-	9067180	-
1,81-1,90 m.	9037190	-	-	-	9067190	-
1,91-2,00 m.	9037200	-	-	-	9067200	-
2,01-2,10 m.	9037210	-	-	-	9067210	-
2,11-2,20 m.	9037220	-	-	-	9067220	-
2,21-2,30 m.	9037230	-	-	-	9067230	-
2,31-2,40 m.	9037240	-	-	-	9067240	-
2,41-2,50 m.	9037250	-	-	-	9067250	-
2,51-2,60 m.	9037260	-	-	-	9067260	-
2,61-2,70 m.	9037270	-	-	-	9067270	-
2,71-2,80 m.	9037280	-	-	-	9067280	-
2,81-2,90 m.	9037290	-	-	-	9067290	-
2,91-3,00 m.	9037300	-	-	-	9067300	-

Výška až do 3,00 m.

<---->	Reference	Kompletní	s tyčkami a bez pásky	bez tyček a pásky	Reference	svislá páska s vlascem
Až do 0,60m.	9038060	-	-	-	9068060	-
0,61-0,70 m.	9038070	-	-	-	9068070	-
0,71-0,80 m.	9038080	-	-	-	9068080	-
0,81-0,90 m.	9038090	-	-	-	9068090	-
0,91-1,00 m.	9038100	-	-	-	9068100	-
1,01-1,10 m.	9038110	-	-	-	9068110	-
1,11-1,20 m.	9038120	-	-	-	9068120	-
1,21-1,30 m.	9038130	-	-	-	9068130	-
1,31-1,40 m.	9038140	-	-	-	9068140	-
1,41-1,50 m.	9038150	-	-	-	9068150	-
1,51-1,60 m.	9038160	-	-	-	9068160	-
1,61-1,70 m.	9038170	-	-	-	9068170	-
1,71-1,80 m.	9038180	-	-	-	9068180	-
1,81-1,90 m.	9038190	-	-	-	9068190	-
1,91-2,00 m.	9038200	-	-	-	9068200	-
2,01-2,10 m.	9038210	-	-	-	9068210	-
2,11-2,20 m.	9038220	-	-	-	9068220	-
2,21-2,30 m.	9038230	-	-	-	9068230	-
2,31-2,40 m.	9038240	-	-	-	9068240	-
2,41-2,50 m.	9038250	-	-	-	9068250	-
2,51-2,60 m.	9038260	-	-	-	9068260	-
2,61-2,70 m.	9038270	-	-	-	9068270	-
2,71-2,80 m.	9038280	-	-	-	9068280	-
2,81-2,90 m.	9038290	-	-	-	9068290	-
2,91-3,00 m.	9038300	-	-	-	9068300	-

## PŘÍSLUŠENSTVÍ

**Kompletní:** Hliníkový profil, koncové kroužky, suchý zip, páska pro řasění, řetízek, šňůra (páska) k navijení, naviják, úchyty, koncovky k profilu, spojka řetízků, hliníková hřídel, uzda, hliníkové závaží, uzávěry, malá řetízková brzda, polyesterové tyče, koncovky k tyči, šrouby, hmoždinky a návod.

**S tyčkami a bez pásky:** Hliníkový profil, koncové kroužky, řetízek, šňůra (páska) k navijení, naviják, úchyty, koncovky k profilu, spojka řetízků, hliníková hřídel, uzda, hliníkové závaží, uzávěry, malá řetízková brzda, polyesterové tyče, koncovky k tyči, šrouby, hmoždinky a návod.

**Bez tyček a bez pásky:** Hliníkový profil, koncové kroužky, řetízek, šňůra (páska) k navijení, naviják, úchyty, koncovky k profilu, spojka řetízků, hliníková hřídel, uzda, hliníkové závaží, uzávěry, malá řetízková brzda, šrouby, hmoždinky a návod.

**Svislá páska s vlascem:** Hliníkový profil, koncové kroužky, suchý zip, svislá páska s vlascem, řetízek, šňůra (páska) k navijení, naviják, úchyty, koncovky k profilu, spojka řetízků, hliníková hřídel, uzda, hliníkové závaží, uzávěry, malá řetízková brzda, šrouby, hmoždinky a návod.

## PŘÍSLUŠENSTVÍ: "STANDARDNÍ"

Komponenty, které Riel Chyc používá při měření:

-Vodiče a držáky: 1,20 m. (2), mezi 1,21 a 2,10 (3), přes 2,10 m. (4)

-Polyesterová tyč Ø4 mm. a koncovky: každých 30 cm.

Dodatečné nebo jiné komponenty budou účtovány dle ceníku. Zátěžové lišty a polyesterové tyče jsou standardně řezány 3 cm. na výšku nepožaduje-li zákazník jinak.



# Římská roleta se sníženým profilem 942, se šňůrou a rychlým snížením



Výška až do 1,80 m.

<---->	Reference	Kompletní	s tyčkami a bez pásky	bez tyček a pásky	Reference	svíslá páska s vlascem
Až do 0,60m.	9039060	-	-	-	9069060	-
0,61-0,70 m.	9039070	-	-	-	9069070	-
0,71-0,80 m.	9039080	-	-	-	9069080	-
0,81-0,90 m.	9039090	-	-	-	9069090	-
0,91-1,00 m.	9039100	-	-	-	9069100	-
1,01-1,10 m.	9039110	-	-	-	9069110	-
1,11-1,20 m.	9039120	-	-	-	9069120	-
1,21-1,30 m.	9039130	-	-	-	9069130	-
1,31-1,40 m.	9039140	-	-	-	9069140	-
1,41-1,50 m.	9039150	-	-	-	9069150	-
1,51-1,60 m.	9039160	-	-	-	9069160	-
1,61-1,70 m.	9039170	-	-	-	9069170	-
1,71-1,80 m.	9039180	-	-	-	9069180	-
1,81-1,90 m.	9039190	-	-	-	9069190	-
1,91-2,00 m.	9039200	-	-	-	9069200	-
2,01-2,10 m.	9039210	-	-	-	9069210	-
2,11-2,20 m.	9039220	-	-	-	9069220	-
2,21-2,30 m.	9039230	-	-	-	9069230	-
2,31-2,40 m.	9039240	-	-	-	9069240	-
2,41-2,50 m.	9039250	-	-	-	9069250	-
2,51-2,60 m.	9039260	-	-	-	9069260	-
2,61-2,70 m.	9039270	-	-	-	9069270	-
2,71-2,80 m.	9039280	-	-	-	9069280	-
2,81-2,90 m.	9039290	-	-	-	9069290	-
2,91-3,00 m.	9039300	-	-	-	9069300	-

Výška až do 3,00 m.

<---->	Reference	Kompletní	s tyčkami a bez pásky	bez tyček a pásky	Reference	svíslá páska s vlascem
Až do 0,60m.	9040060	-	-	-	9070060	-
0,61-0,70 m.	9040070	-	-	-	9070070	-
0,71-0,80 m.	9040080	-	-	-	9070080	-
0,81-0,90 m.	9040090	-	-	-	9070090	-
0,91-1,00 m.	9040100	-	-	-	9070100	-
1,01-1,10 m.	9040110	-	-	-	9070110	-
1,11-1,20 m.	9040120	-	-	-	9070120	-
1,21-1,30 m.	9040130	-	-	-	9070130	-
1,31-1,40 m.	9040140	-	-	-	9070140	-
1,41-1,50 m.	9040150	-	-	-	9070150	-
1,51-1,60 m.	9040160	-	-	-	9070160	-
1,61-1,70 m.	9040170	-	-	-	9070170	-
1,71-1,80 m.	9040180	-	-	-	9070180	-
1,81-1,90 m.	9040190	-	-	-	9070190	-
1,91-2,00 m.	9040200	-	-	-	9070200	-
2,01-2,10 m.	9040210	-	-	-	9070210	-
2,11-2,20 m.	9040220	-	-	-	9070220	-
2,21-2,30 m.	9040230	-	-	-	9070230	-
2,31-2,40 m.	9040240	-	-	-	9070240	-
2,41-2,50 m.	9040250	-	-	-	9070250	-
2,51-2,60 m.	9040260	-	-	-	9070260	-
2,61-2,70 m.	9040270	-	-	-	9070270	-
2,71-2,80 m.	9040280	-	-	-	9070280	-
2,81-2,90 m.	9040290	-	-	-	9070290	-
2,91-3,00 m.	9040300	-	-	-	9070300	-

## PŘÍSLUŠENSTVÍ

**Kompletní:** Hliníkový profil, koncové kroužky, páska pro řazení, suchý zip, koncovky k profilu, držák k uchycení na stěnu i do stropu, malá brzda s řetízem, navijáč se šňůrou, hliníková hřídel, šrouby, hmoždinky, hliníkové závaží, uzávěry, polyesterové tyče a koncovky k tyči.

**S tyčkami a bez pásky:** Hliníkový profil, koncové kroužky, koncovky k profilu, držák k uchycení na stěnu i do stropu, malá brzda s řetízem, navijáč se šňůrou, hliníková hřídel, šrouby, hmoždinky, hliníkové závaží, uzávěry, polyesterové tyče a koncovky k tyči.

**Bez tyček a bez pásky:** Hliníkový profil, koncové kroužky, řetízek, šňůra (páska) k navijení, naviják, úchyty, koncovky k profilu, spojka řetízků, hliníková hřídel, uzda, hliníkové závaží, uzávěry, malá brzda řetězu, šrouby a hmoždinky.

**Svíslá páska s vlascem:** Hliníkový profil, koncové kroužky, suchý zip, páska s kroužky, koncovky k profilu, držák k uchycení na stěnu i do stropu, malá brzda s řetízem, navijáč se šňůrou, hliníková hřídel, šrouby, hmoždinky, hliníkové závaží a uzávěry.

## PŘÍSLUŠENSTVÍ: "STANDARDNÍ"

Komponenty, které Riel Chyc používá při měření:

-Vodiče a držáky: 1.20 m. (2), mezi 1,21 a 2,10 (3), přes 2,10 m. (4)

-Polyesterová tyč Ø4 mm. a koncovky: každých 30 cm.

Dodatečné nebo jiné komponenty budou účtovány dle ceníku. Zátěžové lišty a polyesterové tyče jsou standardně řezány 3 cm. na výšku nepožaduje-li zákazník jinak.

# Římská roleta k uchycení na zed' s profilem 7393, se šňůrou



Výška až do 2,40 m.

<---->	Reference	Kompletní	s tyčkami a bez pásky	bez tyček a pásky	Reference	svislá páska s vlascem
Až do 0,60 m.	9041060	-	-	-	9071060	-
0,61-0,70 m.	9041070	-	-	-	9071070	-
0,71-0,80 m.	9041080	-	-	-	9071080	-
0,81-0,90 m.	9041090	-	-	-	9071090	-
0,91-1,00 m.	9041100	-	-	-	9071100	-
1,01-1,10 m.	9041110	-	-	-	9071110	-
1,11-1,20 m.	9041120	-	-	-	9071120	-
1,21-1,30 m.	9041130	-	-	-	9071130	-
1,31-1,40 m.	9041140	-	-	-	9071140	-
1,41-1,50 m.	9041150	-	-	-	9071150	-
1,51-1,60 m.	9041160	-	-	-	9071160	-
1,61-1,70 m.	9041170	-	-	-	9071170	-
1,71-1,80 m.	9041180	-	-	-	9071180	-
1,81-1,90 m.	9041190	-	-	-	9071190	-
1,91-2,00 m.	9041200	-	-	-	9071200	-
2,01-2,10 m.	9041210	-	-	-	9071210	-
2,11-2,20 m.	9041220	-	-	-	9071220	-
2,21-2,30 m.	9041230	-	-	-	9071230	-
2,31-2,40 m.	9041240	-	-	-	9071240	-
2,41-2,50 m.	9041250	-	-	-	9071250	-
2,51-2,60 m.	9041260	-	-	-	9071260	-
2,61-2,70 m.	9041270	-	-	-	9071270	-
2,71-2,80 m.	9041280	-	-	-	9071280	-
2,81-2,90 m.	9041290	-	-	-	9071290	-
2,91-3,00 m.	9041300	-	-	-	9071300	-

## PŘÍSLUŠENSTVÍ

**Kompletní:** Kroužek, páska pro řasení, suchý zip s vyšším chlupem - párováný, suchý zip, hliníkové závaží, šňůra, brzdové dráty, vodiče šňůry, slepý závit, hliníkový profil, uzávěr, koncovky k profilu, koncovky k tyči, dřevěná rukojeť, spojka šňůry a polyesterová tyč 4 mm.

**S tyčkami a bez pásky:** Kroužek, suchý zip s vyšším chlupem - párováný, suchý zip, hliníkové závaží, šňůra, brzdové dráty, vodiče šňůry, slepý závit, hliníkový profil, uzávěr, koncovky k profilu, koncovky k tyči, dřevěná rukojeť, spojka šňůry a polyesterová tyč 4 mm.

**Bez tyček a bez pásky:** Kroužek, suchý zip s vyšším chlupem - párováný, suchý zip, hliníkové závaží, šňůra, brzdové dráty, vodiče šňůry, slepý závit, hliníkový profil, uzávěr, koncovky k profilu, koncovky k tyči, dřevěná rukojeť, spojka šňůry a polyesterová tyč 4 mm., uzávěr, koncovky k profilu, dřevěná rukojeť a spojka šňůry.

**Svislá páska s vlascem:** Kroužek, suchý zip s vyšším chlupem - párováný, suchý zip, svislá páska s vlascem, hliníkové závaží, šňůra, brzdové dráty, vodiče šňůry, slepý závit, hliníkový profil, uzávěr, koncovky k profilu, dřevěná rukojeť a spojka šňůry.

## PŘÍSLUŠENSTVÍ: "STANDARDNÍ"

Komponenty, které Riel Chyc používá při měření:

-Vodič šňůry a držáky: 1,20 m. (2), mezi 1,21 a 2,10 (3), přes 2,10 m. (4)

-Polyesterová tyč Ø4 mm. a koncovky: každých 30 cm.

Dodatečné nebo jiné komponenty budou účtovány dle ceníku. Zátěžové lišty a polyesterové tyče jsou standardně řezány 3 cm. na výšku nepožaduje-li zákazník jinak.

# Římská roleta "noc a den" s profilem 7393 (oboustranná), se šňůrou



Výška až do 2,40 m.

<---->	Reference	Kompletní	s tyčkami a bez pásky	bez tyček a pásky	Reference	svislá páska s vlascem
Až do 0,60 m.	9042060	-	-	-	9072060	-
0,61-0,70 m.	9042070	-	-	-	9072070	-
0,71-0,80 m.	9042080	-	-	-	9072080	-
0,81-0,90 m.	9042090	-	-	-	9072090	-
0,91-1,00 m.	9042100	-	-	-	9072100	-
1,01-1,10 m.	9042110	-	-	-	9072110	-
1,11-1,20 m.	9042120	-	-	-	9072120	-
1,21-1,30 m.	9042130	-	-	-	9072130	-
1,31-1,40 m.	9042140	-	-	-	9072140	-
1,41-1,50 m.	9042150	-	-	-	9072150	-
1,51-1,60 m.	9042160	-	-	-	9072160	-
1,61-1,70 m.	9042170	-	-	-	9072170	-
1,71-1,80 m.	9042180	-	-	-	9072180	-
1,81-1,90 m.	9042190	-	-	-	9072190	-
1,91-2,00 m.	9042200	-	-	-	9072200	-
2,01-2,10 m.	9042210	-	-	-	9072210	-
2,11-2,20 m.	9042220	-	-	-	9072220	-
2,21-2,30 m.	9042230	-	-	-	9072230	-
2,31-2,40 m.	9042240	-	-	-	9072240	-
2,41-2,50 m.	9042250	-	-	-	9072250	-
2,51-2,60 m.	9042260	-	-	-	9072260	-
2,61-2,70 m.	9042270	-	-	-	9072270	-
2,71-2,80 m.	9042280	-	-	-	9072280	-
2,81-2,90 m.	9042290	-	-	-	9072290	-
2,91-3,00 m.	9042300	-	-	-	9072300	-

## PŘÍSLUŠENSTVÍ

**Kompletní:** Kroužek, páska pro řasení, suchý zip, hliníkové závaží, šňůra, brzdové dráty, vodiče šňůry, slepý závit, hliníkový profil, uzávěr, koncovky k profilu, koncovky k tyči, dřevěná rukojeť, spojka šňůry a polyesterová tyč 4 mm.

**S tyčkami a bez pásky:** Kroužek, suchý zip, hliníkové závaží, šňůra, brzdové dráty, vodiče šňůry, slepý závit, hliníkový profil, uzávěr, koncovky k profilu, koncovky k tyči, dřevěná rukojeť, spojka šňůry a polyesterová tyč 4 mm.

**Bez tyček a bez pásky:** Kroužek, suchý zip, hliníkové závaží, šňůra, brzdové dráty, vodiče šňůry, slepý závit, hliníkový profil, uzávěr, koncovky k profilu, koncovky k tyči, dřevěná rukojeť, spojka šňůry a polyesterová tyč 4 mm., uzávěr, koncovky k profilu, dřevěná rukojeť a spojka šňůry.

**Svislá páska s vlascem:** Kroužek, suchý zip, svislá páska s vlascem, hliníkové závaží, šňůra, brzdové dráty, vodiče šňůry, slepý závit, hliníkový profil, uzávěr, koncovky k profilu, dřevěná rukojeť a spojka šňůry.

## PŘÍSLUŠENSTVÍ: "STANDARDNÍ"

Komponenty, které Riel Chyc používá při měření:

-Vodič šňůry a držáky: 1,20 m. (2), mezi 1,21 a 2,10 (3), přes 2,10 m. (4)

-Polyesterová tyč Ø4 mm. a koncovky: každých 30 cm.

Dodatečné nebo jiné komponenty budou účtovány dle ceníku. Zátěžové lišty a polyesterové tyče jsou standardně řezány 3 cm. na výšku nepožaduje-li zákazník jinak.

## Kompletní římská roleta s profilem 864, se šňůrou



Výška až do 1,80 m.

<---->	Reference	Kompletní	s tyčkami a bez pásky	bez tyček a pásky	Reference	svislá páska s vlascem	Reference	Svislá páska s kroužky
Až do 0,60m.	9043060	-	-	-	9056060	-	9073060	-
0,61-0,70 m.	9043070	-	-	-	9056070	-	9073070	-
0,71-0,80 m.	9043080	-	-	-	9056080	-	9073080	-
0,81-0,90 m.	9043090	-	-	-	9056090	-	9073090	-
0,91-1,00 m.	9043100	-	-	-	9056100	-	9073100	-
1,01-1,10 m.	9043110	-	-	-	9056110	-	9073110	-
1,11-1,20 m.	9043120	-	-	-	9056120	-	9073120	-
1,21-1,30 m.	9043130	-	-	-	9056130	-	9073130	-
1,31-1,40 m.	9043140	-	-	-	9056140	-	9073140	-
1,41-1,50 m.	9043150	-	-	-	9056150	-	9073150	-
1,51-1,60 m.	9043160	-	-	-	9056160	-	9073160	-
1,61-1,70 m.	9043170	-	-	-	9056170	-	9073170	-
1,71-1,80 m.	9043180	-	-	-	9056180	-	9073180	-
1,81-1,90 m.	9043190	-	-	-	9056190	-	9073190	-
1,91-2,00 m.	9043200	-	-	-	9056200	-	9073200	-
2,01-2,10 m.	9043210	-	-	-	9056210	-	9073210	-
2,11-2,20 m.	9043220	-	-	-	9056220	-	9073220	-
2,21-2,30 m.	9043230	-	-	-	9056230	-	9073230	-
2,31-2,40 m.	9043240	-	-	-	9056240	-	9073240	-
2,41-2,50 m.	9043250	-	-	-	9056250	-	9073250	-
2,51-2,60 m.	9043260	-	-	-	9056260	-	9073260	-
2,61-2,70 m.	9043270	-	-	-	9056270	-	9073270	-
2,71-2,80 m.	9043280	-	-	-	9056280	-	9073280	-
2,81-2,90 m.	9043290	-	-	-	9056290	-	9073290	-
2,91-3,00 m.	9043300	-	-	-	9056300	-	9073300	-

Výška až do 3,00 m.

<---->	Reference	Kompletní	s tyčkami a bez pásky	bez tyček a pásky	Reference	svislá páska s vlascem	Reference	Svislá páska s kroužky
Až do 0,60m.	9044060	-	-	-	9057060	-	9074060	-
0,61-0,70 m.	9044070	-	-	-	9057070	-	9074070	-
0,71-0,80 m.	9044080	-	-	-	9057080	-	9074080	-
0,81-0,90 m.	9044090	-	-	-	9057090	-	9074090	-
0,91-1,00 m.	9044100	-	-	-	9057100	-	9074100	-
1,01-1,10 m.	9044110	-	-	-	9057110	-	9074110	-
1,11-1,20 m.	9044120	-	-	-	9057120	-	9074120	-
1,21-1,30 m.	9044130	-	-	-	9057130	-	9074130	-
1,31-1,40 m.	9044140	-	-	-	9057140	-	9074140	-
1,41-1,50 m.	9044150	-	-	-	9057150	-	9074150	-
1,51-1,60 m.	9044160	-	-	-	9057160	-	9074160	-
1,61-1,70 m.	9044170	-	-	-	9057170	-	9074170	-
1,71-1,80 m.	9044180	-	-	-	9057180	-	9074180	-
1,81-1,90 m.	9044190	-	-	-	9057190	-	9074190	-
1,91-2,00 m.	9044200	-	-	-	9057200	-	9074200	-
2,01-2,10 m.	9044210	-	-	-	9057210	-	9074210	-
2,11-2,20 m.	9044220	-	-	-	9057220	-	9074220	-
2,21-2,30 m.	9044230	-	-	-	9057230	-	9074230	-
2,31-2,40 m.	9044240	-	-	-	9057240	-	9074240	-
2,41-2,50 m.	9044250	-	-	-	9057250	-	9074250	-
2,51-2,60 m.	9044260	-	-	-	9057260	-	9074260	-
2,61-2,70 m.	9044270	-	-	-	9057270	-	9074270	-
2,71-2,80 m.	9044280	-	-	-	9057280	-	9074280	-
2,81-2,90 m.	9044290	-	-	-	9057290	-	9074290	-
2,91-3,00 m.	9044300	-	-	-	9057300	-	9074300	-

### PŘÍSLUŠENSTVÍ

**Kompletní:** Kroužek, páska pro řasení, suchý zip, hliníkové závaží, šňůra, brzdové dráty, vodiče šňůry, slepý závit, hliníkový profil, uzávěr, koncovky k profilu, koncovky k tyči, dřevěná rukojeť, spojka šňůry a polyesterová tyč 4 mm.

**S tyčkami a bez pásky:** Kroužek, suchý zip, hliníkové závaží, šňůra, brzdové dráty, vodiče šňůry, slepý závit, hliníkový profil, uzávěr, koncovky k profilu, koncovky k tyči, dřevěná rukojeť, spojka šňůry a polyesterová tyč 4 mm.

**Bez tyček a bez pásky:** Kroužek, suchý zip, hliníkové závaží, šňůra, brzdové dráty, vodiče šňůry, slepý závit, hliníkový profil, uzávěr, koncovky k profilu, koncovky k tyči, dřevěná rukojeť, spojka šňůry a polyesterová tyč 4 mm., uzávěr, koncovky k profilu, dřevěná rukojeť a spojka šňůry.

**Svislá páska s vlascem:** Kroužek, suchý zip, svislá páska s vlascem, hliníkové závaží, šňůra, brzdové dráty, vodiče šňůry, slepý závit, hliníkový profil, uzávěr, koncovky k profilu, dřevěná rukojeť a spojka šňůry.

**Svislá páska s kroužky:** Kroužek, suchý zip, svislá páska s kroužky, hliníkové závaží, šňůra, brzdové dráty, vodiče šňůry, slepý závit, hliníkový profil, uzávěr, koncovky k profilu, dřevěná rukojeť a spojka šňůry.

### PŘÍSLUŠENSTVÍ: "STANDARDNÍ"

Komponenty, které Riel Chyc používá při měření:

-Vodiče šňůry a držáky: 1,20 m. (2), mezi 1,21 a 2,10 (3), přes 2,10 m. (4)

-Polyesterová tyč Ø4 mm. a koncovky: každých 30 cm.

Dodatečné nebo jiné komponenty budou účtovány dle ceníku. Zátěžové lišty a polyesterové tyče jsou standardně řezány 3 cm. na výšku nepožaduje-li zákazník jinak.

# Kompletní římská roleta s profilem 7206, se šnúrou



Výška až do 1,80 m.

<---->	Reference	Kompletní	s tyčkami a bez pásky	bez tyček a pásky	Reference	svíslá páska s vlascem
Až do 0,60m.	9045060	-	-	-	9094060	-
0,61-0,70 m.	9045070	-	-	-	9094070	-
0,71-0,80 m.	9045080	-	-	-	9094080	-
0,81-0,90 m.	9045090	-	-	-	9094090	-
0,91-1,00 m.	9045100	-	-	-	9094100	-
1,01-1,10 m.	9045110	-	-	-	9094110	-
1,11-1,20 m.	9045120	-	-	-	9094120	-
1,21-1,30 m.	9045130	-	-	-	9094130	-
1,31-1,40 m.	9045140	-	-	-	9094140	-
1,41-1,50 m.	9045150	-	-	-	9094150	-
1,51-1,60 m.	9045160	-	-	-	9094160	-
1,61-1,70 m.	9045170	-	-	-	9094170	-
1,71-1,80 m.	9045180	-	-	-	9094180	-
1,81-1,90 m.	9045190	-	-	-	9094190	-
1,91-2,00 m.	9045200	-	-	-	9094200	-
2,01-2,10 m.	9045210	-	-	-	9094210	-
2,11-2,20 m.	9045220	-	-	-	9094220	-
2,21-2,30 m.	9045230	-	-	-	9094230	-
2,31-2,40 m.	9045240	-	-	-	9094240	-
2,41-2,50 m.	9045250	-	-	-	9094250	-
2,51-2,60 m.	9045260	-	-	-	9094260	-
2,61-2,70 m.	9045270	-	-	-	9094270	-
2,71-2,80 m.	9045280	-	-	-	9094280	-
2,81-2,90 m.	9045290	-	-	-	9094290	-
2,91-3,00 m.	9045300	-	-	-	9094300	-

Výška až do 3,00 m.

<---->	Reference	Kompletní	s tyčkami a bez pásky	bez tyček a pásky	Reference	svíslá páska s vlascem
Až do 0,60m.	9046060	-	-	-	9095060	-
0,61-0,70 m.	9046070	-	-	-	9095070	-
0,71-0,80 m.	9046080	-	-	-	9095080	-
0,81-0,90 m.	9046090	-	-	-	9095090	-
0,91-1,00 m.	9046100	-	-	-	9095100	-
1,01-1,10 m.	9046110	-	-	-	9095110	-
1,11-1,20 m.	9046120	-	-	-	9095120	-
1,21-1,30 m.	9046130	-	-	-	9095130	-
1,31-1,40 m.	9046140	-	-	-	9095140	-
1,41-1,50 m.	9046150	-	-	-	9095150	-
1,51-1,60 m.	9046160	-	-	-	9095160	-
1,61-1,70 m.	9046170	-	-	-	9095170	-
1,71-1,80 m.	9046180	-	-	-	9095180	-
1,81-1,90 m.	9046190	-	-	-	9095190	-
1,91-2,00 m.	9046200	-	-	-	9095200	-
2,01-2,10 m.	9046210	-	-	-	9095210	-
2,11-2,20 m.	9046220	-	-	-	9095220	-
2,21-2,30 m.	9046230	-	-	-	9095230	-
2,31-2,40 m.	9046240	-	-	-	9095240	-
2,41-2,50 m.	9046250	-	-	-	9095250	-
2,51-2,60 m.	9046260	-	-	-	9095260	-
2,61-2,70 m.	9046270	-	-	-	9095270	-
2,71-2,80 m.	9046280	-	-	-	9095280	-
2,81-2,90 m.	9046290	-	-	-	9095290	-
2,91-3,00 m.	9046300	-	-	-	9095300	-

## PŘÍSLUŠENSTVÍ

**Kompletní:** Kroužek, páska pro řazení, suchý zip, hliníkové závaží, šňůra, brzdové dráty, vodiče šňůry, slepý závit, hliníkový profil, uzávěr, koncovky k profilu, koncovky k tyči, dřevěná rukojeť, spojka šňůry a polyesterová tyč 4 mm.

**S tyčkami a bez pásky:** Kroužek, suchý zip, hliníkové závaží, šňůra, brzdové dráty, vodiče šňůry, slepý závit, hliníkový profil, uzávěr, koncovky k profilu, koncovky k tyči, dřevěná rukojeť, spojka šňůry a polyesterová tyč 4 mm.

**Bez tyček a bez pásky:** Kroužek, suchý zip, hliníkové závaží, šňůra, brzdové dráty, vodiče šňůry, slepý závit, hliníkový profil, uzávěr, koncovky k profilu, koncovky k tyči, dřevěná rukojeť, spojka šňůry a polyesterová tyč 4 mm., uzávěr, koncovky k profilu, dřevěná rukojeť a spojka šňůry.

**Svíslá páska s vlascem:** Kroužek, suchý zip, svíslá páska s vlascem, hliníkové závaží, šňůra, brzdové dráty, vodiče šňůry, slepý závit, hliníkový profil, uzávěr, koncovky k profilu, dřevěná rukojeť a spojka šňůry.

## PŘÍSLUŠENSTVÍ: "STANDARDNÍ"

Komponenty, které Riel Chyc používá při měření:

-Vodič šňůry a držáky: 1,20 m. (2), mezi 1,21 a 2,10 (3), přes 2,10 m. (4)

-Polyesterová tyč Ø4 mm. a koncovky: každých 30 cm.

Dodatečné nebo jiné komponenty budou účtovány dle ceníku. Zátěžové lišty a polyesterové tyče jsou standardně řezány 3 cm. na výšku nepožaduje-li zákazník jinak.

## Kompletní římská roleta s profilem 942, se šňůrou



Výška až do 1,80 m.

<---->	Reference	Kompletní	s tyčkami a bez pásky	bez tyček a pásky	Reference	svislá páska s vlascem
Až do 0,60m.	9047060	-	-	-	9096060	-
0,61-0,70 m.	9047070	-	-	-	9096070	-
0,71-0,80 m.	9047080	-	-	-	9096080	-
0,81-0,90 m.	9047090	-	-	-	9096090	-
0,91-1,00 m.	9047100	-	-	-	9096100	-
1,01-1,10 m.	9047110	-	-	-	9096110	-
1,11-1,20 m.	9047120	-	-	-	9096120	-
1,21-1,30 m.	9047130	-	-	-	9096130	-
1,31-1,40 m.	9047140	-	-	-	9096140	-
1,41-1,50 m.	9047150	-	-	-	9096150	-
1,51-1,60 m.	9047160	-	-	-	9096160	-
1,61-1,70 m.	9047170	-	-	-	9096170	-
1,71-1,80 m.	9047180	-	-	-	9096180	-
1,81-1,90 m.	9047190	-	-	-	9096190	-
1,91-2,00 m.	9047200	-	-	-	9096200	-
2,01-2,10 m.	9047210	-	-	-	9096210	-
2,11-2,20 m.	9047220	-	-	-	9096220	-
2,21-2,30 m.	9047230	-	-	-	9096230	-
2,31-2,40 m.	9047240	-	-	-	9096240	-
2,41-2,50 m.	9047250	-	-	-	9096250	-
2,51-2,60 m.	9047260	-	-	-	9096260	-
2,61-2,70 m.	9047270	-	-	-	9096270	-
2,71-2,80 m.	9047280	-	-	-	9096280	-
2,81-2,90 m.	9047290	-	-	-	9096290	-
2,91-3,00 m.	9047300	-	-	-	9096300	-

Výška až do 3,00 m.

<---->	Reference	Kompletní	s tyčkami a bez pásky	bez tyček a pásky	Reference	svislá páska s vlascem
Až do 0,60m.	9048060	-	-	-	9093060	-
0,61-0,70 m.	9048070	-	-	-	9093070	-
0,71-0,80 m.	9048080	-	-	-	9093080	-
0,81-0,90 m.	9048090	-	-	-	9093090	-
0,91-1,00 m.	9048100	-	-	-	9093100	-
1,01-1,10 m.	9048110	-	-	-	9093110	-
1,11-1,20 m.	9048120	-	-	-	9093120	-
1,21-1,30 m.	9048130	-	-	-	9093130	-
1,31-1,40 m.	9048140	-	-	-	9093140	-
1,41-1,50 m.	9048150	-	-	-	9093150	-
1,51-1,60 m.	9048160	-	-	-	9093160	-
1,61-1,70 m.	9048170	-	-	-	9093170	-
1,71-1,80 m.	9048180	-	-	-	9093180	-
1,81-1,90 m.	9048190	-	-	-	9093190	-
1,91-2,00 m.	9048200	-	-	-	9093200	-
2,01-2,10 m.	9048210	-	-	-	9093210	-
2,11-2,20 m.	9048220	-	-	-	9093220	-
2,21-2,30 m.	9048230	-	-	-	9093230	-
2,31-2,40 m.	9048240	-	-	-	9093240	-
2,41-2,50 m.	9048250	-	-	-	9093250	-
2,51-2,60 m.	9048260	-	-	-	9093260	-
2,61-2,70 m.	9048270	-	-	-	9093270	-
2,71-2,80 m.	9048280	-	-	-	9093280	-
2,81-2,90 m.	9048290	-	-	-	9093290	-
2,91-3,00 m.	9048300	-	-	-	9093300	-

### PŘÍSLUŠENSTVÍ

**Kompletní:** Kroužek, páska pro řazení, suchý zip, hliníkové závaží, šňůra, brzdové dráty, vodiče šňůry, slepý závit, hliníkový profil, uzávěr, koncovky k profilu, koncovky k tyči, dřevěná rukojeť, spojka šňůry a polyesterová tyč 4 mm.

**S tyčkami a bez pásky:** Kroužek, suchý zip, hliníkové závaží, šňůra, brzdové dráty, vodiče šňůry, slepý závit, hliníkový profil, uzávěr, koncovky k profilu, koncovky k tyči, dřevěná rukojeť, spojka šňůry a polyesterová tyč 4 mm.

**Bez tyček a bez pásky:** Kroužek, suchý zip, hliníkové závaží, šňůra, brzdové dráty, vodiče šňůry, slepý závit, hliníkový profil, uzávěr, koncovky k profilu, koncovky k tyči, dřevěná rukojeť, spojka šňůry a polyesterová tyč 4 mm., uzávěr, koncovky k profilu, dřevěná rukojeť a spojka šňůry.

**Svislá páska s vlascem:** Kroužek, suchý zip, svislá páska s vlascem, hliníkové závaží, šňůra, brzdové dráty, vodiče šňůry, slepý závit, hliníkový profil, uzávěr, koncovky k profilu, dřevěná rukojeť a spojka šňůry.

### PŘÍSLUŠENSTVÍ: "STANDARDNÍ"

**Komponenty, které Riel Chyc používá při měření:**

-Vodič šňůry a držáky: 1,20 m. (2), mezi 1,21 a 2,10 (3), přes 2,10 m. (4)

-Polyesterová tyč Ø4 mm. a koncovky: každých 30 cm.

Dodatečné nebo jiné komponenty budou účtovány dle ceníku. Zátěžové lišty a polyesterové tyče jsou standardně řezány 3 cm. na výšku nepožaduje-li zákazník jinak.

# HLINÍKOVÉ GARNÝŽE

## Hliníková kolejnice s profilem 7247 (ručně ohýbaná)



←----→	Reference	Způsob A Stropní úchyt	Způsob B Úchyt do zdi i do stropu
Až do 1,00 m.	9020100	-	-
1,01-1,25 m.	9020125	-	-
1,26-1,50 m.	9020150	-	-
1,51-1,75 m.	9020175	-	-
1,76-2,00 m.	9020200	-	-
2,01-2,25 m.	9020225	-	-
2,26-2,50 m.	9020250	-	-
2,51-2,75 m.	9020275	-	-
2,76-3,00 m.	9020300	-	-
3,01-3,25 m.	9020325	-	-
3,26-3,50 m.	9020350	-	-
3,51-3,75 m.	9020375	-	-
3,76-4,00 m.	9020400	-	-

### PŘÍSLUŠENSTVÍ

**ZPŮSOB A:** Profil 7247, jezdec (rf. 7283430), střešní spojka "Chyc" (rf. 7285060) a doraz (rf. 7278060).

**ZPŮSOB B:** Profil 7247, jezdec (rf. 7283430), úchyt do zdi i do stropu (rf. 7281060) a doraz (rf. 7278060).

## Hliníková kolejnice s profilem 910 a šňůrou



←----→	Reference	Způsob A standardní	Způsob B se závažím	Způsob C Způsob A s tažným jezdcem a kolečky	Způsob D Způsob B s tažným jezdcem a kolečky
Až do 1,00 m.	9021100	-	-	-	-
1,01-1,25 m.	9021125	-	-	-	-
1,26-1,50 m.	9021150	-	-	-	-
1,51-1,75 m.	9021175	-	-	-	-
1,76-2,00 m.	9021200	-	-	-	-
2,01-2,25 m.	9021225	-	-	-	-
2,26-2,50 m.	9021250	-	-	-	-
2,51-2,75 m.	9021275	-	-	-	-
2,76-3,00 m.	9021300	-	-	-	-
3,01-3,25 m.	9021325	-	-	-	-
3,26-3,50 m.	9021350	-	-	-	-
3,51-3,75 m.	9021375	-	-	-	-
3,76-4,00 m.	9021400	-	-	-	-

### PŘÍSLUŠENSTVÍ

**ZPŮSOB A:** Profil 910, jezdec (rf. 1072060), tažný jezdec s patkou (rf. 0914060), tažný jezdec (rf. 0912060), napínák s uchycením do zdi (rf. 0419060), držák do zdi (rf. 0901060) a koncové pouzdro (kladka) pro ovládání šňůry (rf. 0958060).

**ZPŮSOB B:** Profil 910, jezdec (rf. 1072060), tažný jezdec s patkou (rf. 0914060), tažný jezdec (rf. 0912060), závaží (rf. 1224060), držák do zdi (rf. 0901060) a koncové pouzdro (kladka) pro ovládání šňůry (rf. 0958060).

**ZPŮSOB C:** Profil 910, jezdec (rf. 0907060), tažný jezdec s kolečky a patkou (rf. 0911060), tažný jezdec s kolečky (rf. 0951060), napínák s uchycením do zdi (rf. 0419060), držák do zdi (rf. 0901060) a koncové pouzdro (kladka) pro ovládání šňůry (rf. 0958060).

**ZPŮSOB D:** Profil 910, jezdec (rf. 0907060), tažný jezdec s kolečky a patkou (rf. 0911060), tažný jezdec s kolečky (rf. 0951060), závaží (rf. 1224060), držák do zdi (rf. 0901060) a koncové pouzdro (kladka) pro ovládání šňůry (rf. 0958060).

# HLINÍKOVÉ GARNÝŽE

Hliníková kolejnice s profilem 910, bez šňůry, s úchytem do zdi i do stropu



←----→	Reference	Způsob A standardní	Způsob B Jezdec - jednoduchý s kolečkem	Způsob C Způsob A s tažným jezdcem a kolečky	Způsob D Způsob B s tažným jezdcem a kolečky
Až do 1,00 m.	9022100	-	-	-	-
1,01-1,25 m.	9022125	-	-	-	-
1,26-1,50 m.	9022150	-	-	-	-
1,51-1,75 m.	9022175	-	-	-	-
1,76-2,00 m.	9022200	-	-	-	-
2,01-2,25 m.	9022225	-	-	-	-
2,26-2,50 m.	9022250	-	-	-	-
2,51-2,75 m.	9022275	-	-	-	-
2,76-3,00 m.	9022300	-	-	-	-
3,01-3,25 m.	9022325	-	-	-	-
3,26-3,50 m.	9022350	-	-	-	-
3,51-3,75 m.	9022375	-	-	-	-
3,76-4,00 m.	9022400	-	-	-	-

## PŘÍSLUŠENSTVÍ

**ZPŮSOB A:** Profil 910, jezdec (rf. 1072060), úchyt do zdi i do stropu (rf. 1509060) a doraz (rf. 0905060).

**ZPŮSOB B:** Profil 910, jezdec (rf. 0907060), úchyt do zdi i do stropu (rf. 1509060) a doraz (rf. 0905060).

**ZPŮSOB C:** Profil 910, jezdec (rf. 1072060), tažný jezdec s patkou (rf. 0913060), tažný jezdec (rf. 0962060), úchyt do zdi i do stropu (rf. 1509060), a doraz (rf. 0905060).

**ZPŮSOB D:** Profil 910, jezdec (rf. 0907060), tažný jezdec s kolečky a patkou (rf. 0952060), tažný jezdec s kolečky (rf. 0953060), úchyt do zdi i do stropu (rf. 1509060), a doraz (rf. 0905060).

Hliníková kolejnice s profilem 910, bez šňůry, se stropním držákem - podpěrou



←----→	Reference	Způsob A standardní	Způsob B Jezdec - jednoduchý s kolečkem	Způsob C Způsob A s tažným jezdcem a kolečky	Způsob D Způsob B s tažným jezdcem a kolečky
Až do 1,00 m.	9023100	-	-	-	-
1,01-1,25 m.	9023125	-	-	-	-
1,26-1,50 m.	9023150	-	-	-	-
1,51-1,75 m.	9023175	-	-	-	-
1,76-2,00 m.	9023200	-	-	-	-
2,01-2,25 m.	9023225	-	-	-	-
2,26-2,50 m.	9023250	-	-	-	-
2,51-2,75 m.	9023275	-	-	-	-
2,76-3,00 m.	9023300	-	-	-	-
3,01-3,25 m.	9023325	-	-	-	-
3,26-3,50 m.	9023350	-	-	-	-
3,51-3,75 m.	9023375	-	-	-	-
3,76-4,00 m.	9023400	-	-	-	-

## PŘÍSLUŠENSTVÍ

**ZPŮSOB A:** Profil 910, jezdec (rf. 1072060), stropní držák - podpěra (rf. 0993060) a doraz (rf. 0905060).

**ZPŮSOB B:** Profil 910, jezdec (rf. 0907060), stropní držák - podpěra (rf. 0993060) a doraz (rf. 0905060).

**ZPŮSOB C:** Profil 910, jezdec (rf. 1072060), tažný jezdec s patkou (rf. 0913060), tažný jezdec (rf. 0962060), stropní držák - podpěra (rf. 0993060) a doraz (rf. 0905060).

**ZPŮSOB D:** Profil 910, jezdec (rf. 0907060), tažný jezdec s kolečky a patkou (rf. 0952060), tažný jezdec s kolečky (rf. 0953060), stropní držák - podpěra (rf. 0993060) a doraz (rf. 0905060).



# HLINÍKOVÉ GARNÝŽE

## Hliníková kolejnice s profilem 950 a šňůrou



<---->	Reference	Způsob A standardní	Způsob B se závažím
Až do 1,00 m.	9024100	-	-
1,01-1,25 m.	9024125	-	-
1,26-1,50 m.	9024150	-	-
1,51-1,75 m.	9024175	-	-
1,76-2,00 m.	9024200	-	-
2,01-2,25 m.	9024225	-	-
2,26-2,50 m.	9024250	-	-
2,51-2,75 m.	9024275	-	-
2,76-3,00 m.	9024300	-	-
3,01-3,25 m.	9024325	-	-
3,26-3,50 m.	9024350	-	-
3,51-3,75 m.	9024375	-	-
3,76-4,00 m.	9024400	-	-

### PŘÍSLUŠENSTVÍ

**ZPŮSOB A:** Profil 950, jezdec (rf. 0906060), tažný jezdec s patkou (rf. 0913060), tažný jezdec (rf. 0962060), napínák s uchycením do zdi (rf. 0419060), držák do zdi (rf. 0901060) a koncové pouzdro (kladka) pro ovládání šňůry (rf. 0957060).

**ZPŮSOB B:** Profil 950, jezdec (rf. 0906060), tažný jezdec s patkou (rf. 0913060), tažný jezdec (rf. 0962060), závaží (rf. 1224060), držák do zdi (rf. 0901060) a koncové pouzdro (kladka) pro ovládání šňůry (rf. 0957060).

*Pro stříbrné kolejnice navýšení ceny o 3%.*

## Hliníková kolejnice s profilem 950, bez šňůry



<---->	Reference	Způsob A standardní	Způsob B Jezdec - jednoduchý s kolečkem	Způsob C Způsob A s tažným jezdcem a kolečkem	Způsob D Způsob B s tažným jezdcem a kolečkem
Až do 1,00 m.	9025100	-	-	-	-
1,01-1,25 m.	9025125	-	-	-	-
1,26-1,50 m.	9025150	-	-	-	-
1,51-1,75 m.	9025175	-	-	-	-
1,76-2,00 m.	9025200	-	-	-	-
2,01-2,25 m.	9025225	-	-	-	-
2,26-2,50 m.	9025250	-	-	-	-
2,51-2,75 m.	9025275	-	-	-	-
2,76-3,00 m.	9025300	-	-	-	-
3,01-3,25 m.	9025325	-	-	-	-
3,26-3,50 m.	9025350	-	-	-	-
3,51-3,75 m.	9025375	-	-	-	-
3,76-4,00 m.	9025400	-	-	-	-

### PŘÍSLUŠENSTVÍ

**ZPŮSOB A:** Profil 950, jezdec (rf. 1072060), stropní držák - podpěra (rf. 0993060) a doraz (rf. 0905060).

**ZPŮSOB B:** Profil 950, jezdec (rf. 0907060), stropní držák - podpěra (rf. 0993060) a doraz (rf. 0905060).

**ZPŮSOB C:** Profil 950, Jezdec (rf. 1072060), tažný jezdec s patkou (rf. 0913060), tažný jezdec (rf. 0962060), stropní držák - podpěra (rf. 0993060) a doraz (rf. 0905060).

**ZPŮSOB D:** Profil 950, jezdec (rf. 0907060), tažný jezdec s kolečkem a patkou (rf. 0952060), tažný jezdec s kolečkem (rf. 0953060), stropní držák - podpěra (rf. 0993060), a doraz (rf. 0905060).

# HLINÍKOVÉ GARNÝŽE

## Kolejnice na míru s pravidelnou vlnou, profil 7600, bílá



←----→	Reference	ZPŮSOB A	ZPŮSOB B
		Délka tyče (vlna 9 cm)	Délka tyče (vlna 6 cm)
		<b>A1:</b> roztažení ke straně, se šňůrou <b>A2:</b> roztažení ke straně, bez šňůry <b>A3:</b> roztažení oponové, se šňůrou <b>A4:</b> roztažení oponové, bez šňůry	<b>B1:</b> roztažení ke straně, se šňůrou <b>B2:</b> roztažení ke straně, bez šňůry <b>B3:</b> roztažení oponové, se šňůrou <b>B4:</b> roztažení oponové, bez šňůry
Až do 0,90 m.	9030090	-	-
0,91-1,20 m.	9030120	-	-
1,21-1,50 m.	9030150	-	-
1,51-1,80 m.	9030180	-	-
1,81-2,10 m.	9030210	-	-
2,11-2,40 m.	9030240	-	-
2,41-2,70 m.	9030270	-	-
2,71-3,00 m.	9030300	-	-
3,01-3,30 m.	9030330	-	-
3,31-3,60 m.	9030360	-	-
3,61-3,90 m.	9030390	-	-
3,91-4,20 m.	9030420	-	-
4,21-4,50 m.	9030450	-	-

## Kolejnice na míru s pravidelnou vlnou, profil 7600, šedá

←----→	Reference	ZPŮSOB A	ZPŮSOB B
		Délka tyče (vlna 9 cm)	Délka tyče (vlna 6 cm)
		<b>A1:</b> roztažení ke straně, se šňůrou <b>A2:</b> roztažení ke straně, bez šňůry <b>A3:</b> roztažení oponové, se šňůrou <b>A4:</b> roztažení oponové, bez šňůry	<b>B1:</b> roztažení ke straně, se šňůrou <b>B2:</b> roztažení ke straně, bez šňůry <b>B3:</b> roztažení oponové, se šňůrou <b>B4:</b> roztažení oponové, bez šňůry
Až do 0,90 m.	9031090	-	-
0,91-1,20 m.	9031120	-	-
1,21-1,50 m.	9031150	-	-
1,51-1,80 m.	9031180	-	-
1,81-2,10 m.	9031210	-	-
2,11-2,40 m.	9031240	-	-
2,41-2,70 m.	9031270	-	-
2,71-3,00 m.	9031300	-	-
3,01-3,30 m.	9031330	-	-
3,31-3,60 m.	9031360	-	-
3,61-3,90 m.	9031390	-	-
3,91-4,20 m.	9031420	-	-
4,21-4,50 m.	9031450	-	-

### PŘÍSLUŠENSTVÍ

**ZPŮSOB A1 (roztažení ke straně, se šňůrou):** profil 7600, tažný jezdec (rf. 0241\*\*0), rozdělovač 9 cm (rf. 0246\*\*0), tažný jezdec (rf. 0242\*\*0), spojka šňůry (rf. 0245\*\*0), stropní držák (rf. 0252\*\*0), držák hladký (rf. 0250\*\*0) a šňůra (rf. 2551\*\*0)

**ZPŮSOB A2 (roztažení ke straně, bez šňůry):** profil 7600, tažný jezdec (rf. 0241\*\*0), rozdělovač 9 cm (rf. 0246\*\*0), stropní držák (rf. 0252\*\*0), koncovka (rf. 7605\*\*0)

**ZPŮSOB A3 (roztažení oponové, se šňůrou):** profil 7600, tažný jezdec (rf. 0241\*\*0), rozdělovač 9 cm (rf. 0246\*\*0), tažný jezdec (rf. 0242\*\*0), spojka šňůry (rf. 0245\*\*0), stropní držák (rf. 0252\*\*0), držák hladký (rf. 0250\*\*0) a šňůra (rf. 2551\*\*0)

**ZPŮSOB A4 (roztažení oponové, bez šňůry):** profil 7600, tažný jezdec (rf. 0241\*\*0), rozdělovač 9 cm (rf. 0246\*\*0), stropní držák (rf. 0252\*\*0), koncovka (rf. 7605\*\*0)

**ZPŮSOB B1 (roztažení ke straně, se šňůrou):** profil 7600, tažný jezdec (rf. 0241\*\*0), rozdělovač 6 cm (rf. 0247\*\*0), tažný jezdec (rf. 0242\*\*0), spojka šňůry (rf. 0245\*\*0), stropní držák (rf. 0252\*\*0), držák hladký (rf. 0250\*\*0) a šňůra (rf. 2551\*\*0)

**ZPŮSOB B2 (roztažení ke straně, bez šňůry):** profil 7600, tažný jezdec (rf. 0241\*\*0), rozdělovač 6 cm (rf. 0247\*\*0), stropní držák (rf. 0252\*\*0), koncovka (rf. 7605\*\*0)

**ZPŮSOB B3 (roztažení oponové, se šňůrou):** profil 7600, tažný jezdec (rf. 0241\*\*0), rozdělovač 6 cm (rf. 0247\*\*0), tažný jezdec (rf. 0242\*\*0), spojka šňůry (rf. 0245\*\*0), stropní držák (rf. 0252\*\*0), držák hladký (rf. 0250\*\*0) a šňůra (rf. 2551\*\*0)

**ZPŮSOB B4 (roztažení oponové, bez šňůry):** profil 7600, tažný jezdec (rf. 0241\*\*0), rozdělovač 6 cm (rf. 0247\*\*0), stropní držák (rf. 0252\*\*0), koncovka (rf. 7605\*\*0)

# HLINÍKOVÉ GARNÝŽE

## Hliníková kolejnice s profilem 7288, bez šňůry, děrovaná



←----→	Reference	Způsob A standardní	Způsob B Jezdec - jednoduchý s kolečkem	Způsob C Způsob A s tažným jezdcem a kolečky	Způsob D Způsob B s tažným jezdcem a kolečky
Až do 1,00 m.	9026100	-	-	-	-
1,01-1,25 m.	9026125	-	-	-	-
1,26-1,50 m.	9026150	-	-	-	-
1,51-1,75 m.	9026175	-	-	-	-
1,76-2,00 m.	9026200	-	-	-	-
2,01-2,25 m.	9026225	-	-	-	-
2,26-2,50 m.	9026250	-	-	-	-
2,51-2,75 m.	9026275	-	-	-	-
2,76-3,00 m.	9026300	-	-	-	-
3,01-3,25 m.	9026325	-	-	-	-
3,26-3,50 m.	9026350	-	-	-	-
3,51-3,75 m.	9026375	-	-	-	-
3,76-4,00 m.	9026400	-	-	-	-

### PŘÍSLUŠENSTVÍ

**ZPŮSOB A:** Profil 7288, 2 kolejnice, jezdec (rf. 1072060) a doraz (rf. 7301060).

**ZPŮSOB B:** Profil 7288, 2 kolejnice, jezdec (rf. 0907060), a doraz (rf. 7301060).

**ZPŮSOB C:** Profil 7288, 2 kolejnice, jezdec (rf. 1072060), tažný jezdec s patkou (rf. 0856060), tažný jezdec (rf. 0962060) a doraz (rf. 7301060).

**ZPŮSOB D:** Profil 7288, 2 kolejnice, jezdec (rf. 0907060), tažný jezdec s kolečky a krátkou patkou (rf. 0851060), tažný jezdec s kolečky (rf. 0953060) a doraz (rf. 7301060).

## Hliníková kolejnice s profilem 7269, bez šňůry, děrovaná



←----→	Reference	Způsob A standardní	Způsob B Jezdec - jednoduchý s kolečkem	Způsob C Způsob A s tažným jezdcem a kolečky	Způsob D Způsob B s tažným jezdcem a kolečky
Až do 1,00 m.	9027100	-	-	-	-
1,01-1,25 m.	9027125	-	-	-	-
1,26-1,50 m.	9027150	-	-	-	-
1,51-1,75 m.	9027175	-	-	-	-
1,76-2,00 m.	9027200	-	-	-	-
2,01-2,25 m.	9027225	-	-	-	-
2,26-2,50 m.	9027250	-	-	-	-
2,51-2,75 m.	9027275	-	-	-	-
2,76-3,00 m.	9027300	-	-	-	-
3,01-3,25 m.	9027325	-	-	-	-
3,26-3,50 m.	9027350	-	-	-	-
3,51-3,75 m.	9027375	-	-	-	-
3,76-4,00 m.	9027400	-	-	-	-

### PŘÍSLUŠENSTVÍ

**ZPŮSOB A:** Profil 7269, 2 kolejnice, jezdec (rf. 1072060) a doraz (rf. 7301060).

**ZPŮSOB B:** Profil 7269, 2 kolejnice, jezdec (rf. 0907060), a doraz (rf. 7301060).

**ZPŮSOB C:** Profil 7269, 2 kolejnice, jezdec (rf. 1072060), tažný jezdec s patkou (rf. 0913060), tažný jezdec (rf. 0962060) a doraz (rf. 7301060).

**ZPŮSOB D:** Profil 7269, 2 kolejnice, jezdec (rf. 0907060), tažný jezdec s kolečky a patkou (rf. 0952060), tažný jezdec s kolečky (rf. 0953060) a doraz (rf. 7301060).

# HLINÍKOVÉ GARNÝŽE

Hliníková kolejnice s profilem I129, bez šňůry, děrovaná



<---->	Reference	Způsob A standardní	Způsob B Jezdec jednoduchý s kolečkem	Způsob C Způsob A s tažným jezdcem a kolečky	Způsob D Způsob B s tažným jezdcem a kolečky
Až do 1,00 m.	9028100	-	-	-	-
1,01-1,25 m.	9028125	-	-	-	-
1,26-1,50 m.	9028150	-	-	-	-
1,51-1,75 m.	9028175	-	-	-	-
1,76-2,00 m.	9028200	-	-	-	-
2,01-2,25 m.	9028225	-	-	-	-
2,26-2,50 m.	9028250	-	-	-	-
2,51-2,75 m.	9028275	-	-	-	-
2,76-3,00 m.	9028300	-	-	-	-
3,01-3,25 m.	9028325	-	-	-	-
3,26-3,50 m.	9028350	-	-	-	-
3,51-3,75 m.	9028375	-	-	-	-
3,76-4,00 m.	9028400	-	-	-	-

## PŘÍSLUŠENSTVÍ

**ZPŮSOB A:** Profil 1129, 3 kolejnice, jezdec (rf. 1072060) a doraz (rf. 7301060).

**ZPŮSOB B:** Profil 1129, 3 kolejnice, jezdec (rf. 0907060) a doraz (rf. 7301060).

**ZPŮSOB C:** Profil 1129, 3 kolejnice, jezdec (rf. 1072060), tažný jezdec s patkou (rf. 0913060), tažný jezdec (rf. 0962060) a doraz (rf. 7301060).

**ZPŮSOB D:** Profil 1129, 3 kolejnice, jezdec (rf. 0907060), tažný jezdec s kolečky a patkou (rf. 0952060), tažný jezdec s kolečky (rf. 0953060) a doraz (rf. 7301060).

Hliníková kolejnice s profilem I078, vhodná pro nastavbu P-7206 se suchým zipem

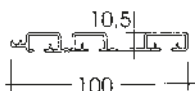

P-1078



P-7206

# LAKOVANÉ, LITINOVÉ KOLEJNICE

## Pevná, čelní kolejnice, systém stažení v pravo, v levo nebo centrální (oponové)



### Se šňůrou

<---->	Reference	Jednoduché	S dvojitým ovládním
Až do 1,00 m.	9001100	-	-
1,01-1,25 m.	9001125	-	-
1,26-1,50 m.	9001150	-	-
1,51-1,75 m.	9001175	-	-
1,76-2,00 m.	9001200	-	-
2,01-2,25 m.	9001225	-	-
2,26-2,50 m.	9001250	-	-
2,51-2,75 m.	9001275	-	-
2,76-3,00 m.	9001300	-	-
3,01-3,25 m.	9001325	-	-
3,26-3,50 m.	9001350	-	-
3,51-3,75 m.	9001375	-	-
3,76-4,00 m.	9001400	-	-
4,01-4,25 m.	9001425	-	-
4,26-4,50 m.	9001450	-	-

### Bez šňůry

<---->	Reference	Jednoduché	S dvojitým ovládním
Až do 1,00 m.	9002100	-	-
1,01-1,25 m.	9002125	-	-
1,26-1,50 m.	9002150	-	-
1,51-1,75 m.	9002175	-	-
1,76-2,00 m.	9002200	-	-
2,01-2,25 m.	9002225	-	-
2,26-2,50 m.	9002250	-	-
2,51-2,75 m.	9002275	-	-
2,76-3,00 m.	9002300	-	-
3,01-3,25 m.	9002325	-	-
3,26-3,50 m.	9002350	-	-
3,51-3,75 m.	9002375	-	-
3,76-4,00 m.	9002400	-	-
4,01-4,25 m.	9002425	-	-
4,26-4,50 m.	9002450	-	-

### PŘÍSLUŠENSTVÍ

Jednoduchý jezdec, oboustranný tažný jezdec, koncové stropní pouzdro, centrální držák, boční držák, šňůra, závaží, hmoždinka a šroub.

### PŘÍSLUŠENSTVÍ

Jednoduchý jezdec, doraz, centrální držák, hmoždinka a šroub.

## Pevná, stropní kolejnice, systém stažení v pravo, v levo nebo centrální (oponové)



### Se šňůrou

<---->	Reference	Jednoduché	S dvojitým ovládním
Až do 1,00 m.	9003100	-	-
1,01-1,25 m.	9003125	-	-
1,26-1,50 m.	9003150	-	-
1,51-1,75 m.	9003175	-	-
1,76-2,00 m.	9003200	-	-
2,01-2,25 m.	9003225	-	-
2,26-2,50 m.	9003250	-	-
2,51-2,75 m.	9003275	-	-
2,76-3,00 m.	9003300	-	-
3,01-3,25 m.	9003325	-	-
3,26-3,50 m.	9003350	-	-
3,51-3,75 m.	9003375	-	-
3,76-4,00 m.	9003400	-	-
4,01-4,25 m.	9003425	-	-
4,26-4,50 m.	9003450	-	-

### Bez šňůry

<---->	Reference	Jednoduché	S dvojitým ovládním
Až do 1,00 m.	9004100	-	-
1,01-1,25 m.	9004125	-	-
1,26-1,50 m.	9004150	-	-
1,51-1,75 m.	9004175	-	-
1,76-2,00 m.	9004200	-	-
2,01-2,25 m.	9004225	-	-
2,26-2,50 m.	9004250	-	-
2,51-2,75 m.	9004275	-	-
2,76-3,00 m.	9004300	-	-
3,01-3,25 m.	9004325	-	-
3,26-3,50 m.	9004350	-	-
3,51-3,75 m.	9004375	-	-
3,76-4,00 m.	9004400	-	-
4,01-4,25 m.	9004425	-	-
4,26-4,50 m.	9004450	-	-

### PŘÍSLUŠENSTVÍ

Jednoduchý jezdec, tažný jezdec pevný, koncové stropní pouzdro, centrální držák, šňůra, závaží, hmoždinka a šroub.

### PŘÍSLUŠENSTVÍ

Jednoduchý jezdec, doraz, centrální držák, hmoždinka a šroub.





# MUESTRARIOS



# Vzorníky - Zirconio

Nástěnný vzorník 60x60, zirconio 28-20 mm.



Nástěnný vzorník 60x60, zirconio 20 mm., kombinovaný



REF.	<b>4220000</b>	<b>2245000</b>
Čisté náklady	<b>4.650 Kč/Ks</b>	<b>3.748 Kč/Ks</b>

Nástěnný vzorník 60x60, zirconio 28-20 mm.

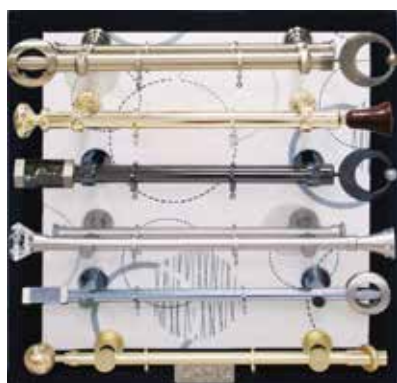

Stolní vzorník, zirconio 28-20 mm.



**Novinka**

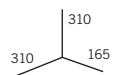

REF.	<b>4094000</b>	<b>4084000</b>
Čisté náklady	<b>4.650 Kč/Ks</b>	<b>3.741 Kč/Ks</b>

Stolní vzorník, zirconio 28-20 mm.



Barevnice zirconia a dřeva v plastovém pouzdru

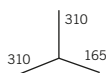

**Novinka**

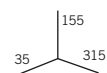

REF.	<b>4093000</b>	<b>4211000</b>
Čisté náklady	<b>3.477 Kč/Ks</b>	<b>589 Kč/Ks</b>



## Vzorníky - Zirconio

Stolní vzorník zirconio 20x20 mm.

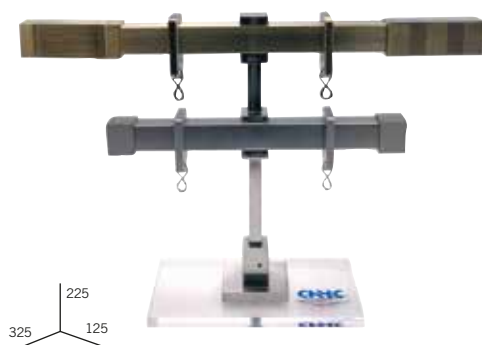

325  
225  
125

Stolní vzorník mosaz "Élite" 28-20 mm.

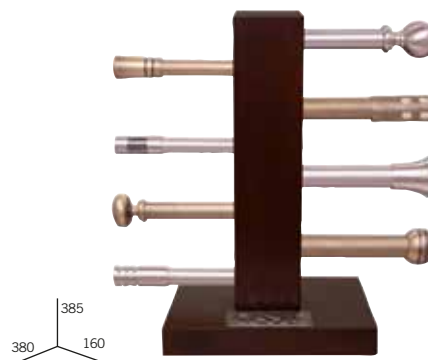

385  
380  
160

REF.	<b>4088000</b>	<b>2199000</b>
Čisté náklady	<b>1.046 Kč/Ks</b>	<b>4.447 Kč/Ks</b>

## Vzorníky - kování

Nástěnný vzorník kování 28, 20 a 12 mm.



Nástěnný vzorník kování 28-20 mm, 60x60



REF.	<b>4133200</b>	<b>1184000</b>
Čisté náklady	<b>6.196 Kč/Ks</b>	<b>4.285 Kč/Ks</b>

Stolní vzorník, kování 28-20 mm.



330  
300  
165

Barevnice kování 20 mm.  
v plastovém pouzdrú



155  
35  
315

REF.	<b>4080000</b>	<b>4077000</b>
Čisté náklady	<b>3.052 Kč/Ks</b>	<b>831 Kč/Ks</b>

# Vzorníky - dřevo

Nástěnný vzorník dřeva 28, 20 a 12 mm, (67x73)



Nástěnný vzorník dřeva 28, 20 a 12 mm, 60x60



REF. **1799200**

Čisté  
náklady

**3.568 Kč/Ks**

REF. **1183000**

**2.592 Kč/Ks**

Stolní vzorník, dřevo 28-20 mm.



300  
250  
165

Nástěnný vzorník dřeva 50 mm, 47x40



770  
400  
210

REF. **2177000**

Čisté  
náklady

**1.424 Kč/Ks**

REF. **1828000**

**4.524 Kč/Ks**

# Vzorníky - japonská stěna

Vzorník japonské stěny - tříkanálový  
(K dispozici v bílé a stříbrné barvě)



Vzorník japonské stěny - čtyřkanálový



REF. **1069060/ 1069400**

Čisté  
náklady

**314** Kč/Ks

REF. **1070060**

**483** Kč/Ks

Vzorník japonské stěny s římskou roletou



Vzorník profilů pro japonskou stěnu



REF. **2187060**

Čisté  
náklady

**270** Kč/Ks

REF. **1952000**

**261** Kč/Ks

# Vzorníky - římská roleta

Nástěnný vzorník římských roletek, 60x60



Nástěnný vzorník 950 - římská roleta v kombinaci s kovanou tyčí 28 mm.



REF. **1567000**

Čisté  
náklady **5.328 Kč/Ks**

**2961004**

**1.690 Kč/Ks**

Kompaktní vzorek římské roletky

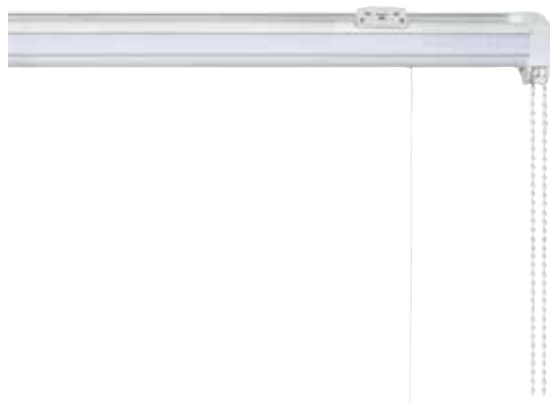

Vzorník římské roletky s rychlým snížením



REF. **1130060**

Čisté  
náklady **375 Kč/Ks**

**1871060**

**245 Kč/Ks**

Vzorník římské roletky 7206 s řetízkem



Vzorník římské roletky 942 se snížením



REF. **1597004**

Čisté  
náklady **672 Kč/Ks**

**1988060**

**211 Kč/Ks**

# Vzorníky - římská roleta

Vzorník oboustranné římské roletky



Vzorník římské roletky 864 se šňůrou



<b>REF.</b>	<b>2176000</b>	<b>1596004</b>
Čisté náklady	289 Kč/Ks	679 Kč/Ks

Vzorník římské roletky 7206 se šňůrou



Vzorník římské roletky 942 se šňůrou



<b>REF.</b>	<b>2243060</b>	<b>1992060</b>
Čisté náklady	234 Kč/Ks	71 Kč/Ks

Vzorník hliníkových profilů se suchým zipem



<b>REF.</b>	<b>2221060</b>
Čisté náklady	665 Kč/Ks

# Vzorníky - hliníkové kolejnice

Vzorník hliníkové kolejnice 60x60



Vzorník hliníkové kolejnice 60x60



**Novinka**

REF.	<b>1185000</b>	<b>1120000</b>
Čisté náklady	<b>2.788 Kč/Ks</b>	<b>1.887 Kč/Ks</b>

Vzorník hliníkové kolejnice/ litinové kolejnice 60x60



**Novinka**

Vzorník uchycení hliníkových kolejnic v prostoru



REF.	<b>1983000</b>	<b>1068060</b>
Čisté náklady	<b>4.537 Kč/Ks</b>	<b>489 Kč/Ks</b>

Vzorník dvojitého držáku P-908



Vzorník hliníkových profilů



REF.	<b>2200060</b>	<b>2220060</b>
Čisté náklady	<b>406 Kč/Ks</b>	<b>665 Kč/Ks</b>

# Vzorníky - hliníkové kolejnice

Vzorník hliníkové kolejnice systém "Ondas" P-7600

**Novinka**



Vzorník hliníkové kolejnice P-7247



REF.	<b>7602060</b>	<b>1940064</b>
Čisté náklady	<b>132 Kč/Ks</b>	<b>75 Kč/Ks</b>

Vzorník hliníkové kolejnice P-910, se šňůrou



Vzorník hliníkové kolejnice P-910, bez šňůry



REF.	<b>1923064</b>	<b>1924064</b>
Čisté náklady	<b>122 Kč/Ks</b>	<b>50 Kč/Ks</b>

Vzorník hliníkové kolejnice P-950, se šňůrou



Vzorník hliníkové kolejnice P-950, bez šňůry



REF.	<b>1921064</b>	<b>1922064</b>
Čisté náklady	<b>96 Kč/Ks</b>	<b>46 Kč/Ks</b>



## Vzorník - litinové kolejnice a vitrážky

Nástěnný vzorník 60x60 litinových kolejnic a vitrážek



Vzorník litinové kolejnice "DA-LUZ"



REF.	<b>1918000</b>	<b>0214060</b>
Čisté náklady	<b>2.587 Kč/Ks</b>	<b>25 Kč/Ks</b>

## Vzorník - dekorační kryty

Nástěnný vzorník dekoračních krytů 47x40



Volně stojící vzorník dekoračních krytů



Barevnice dekoračních krytů



REF.	<b>1292000</b>	<b>1487000</b>	<b>1333000</b>
Čisté náklady	<b>2.268 Kč/Ks</b>	<b>1.227 Kč/Ks</b>	<b>535 Kč/Ks</b>

## Vzorník pásek a kovových kroužků

Vzorník pásek



Vzorník kroužků



Novinka

REF.	<b>2216000</b>	<b>2253000</b>
Čisté náklady	<b>645 Kč/Ks</b>	<b>296 Kč/Ks</b>



# Čelní panely "F" k vystavovacím vitrínám, 80 cm.

Čelní panel - kování 28 mm (750x443)



Čelní panel - kování 20 mm (750x443)



REF.	<b>190000</b>	<b>192000</b>
Čisté náklady	<b>3.299 Kč/Ks</b>	<b>2.265 Kč/Ks</b>

Čelní panel - dřevo 28 m (750 X 443)



Čelní panel - dřevo 20 m (750 X 443)



REF.	<b>191900</b>	<b>419900</b>
Čisté náklady	<b>2.166 Kč/Ks</b>	<b>1.602 Kč/Ks</b>

Čelní panel - kované vitrážky 10 mm (750x 443)



Čelní panel - rozpěrné kolejničky a vitrážky (750x443)



REF.	<b>420600</b>	<b>420700</b>
Čisté náklady	<b>1.500 Kč/Ks</b>	<b>1.500 Kč/Ks</b>

# Čelní panely "F" k vystavovacím vitrínám, 80 cm.

Čelní panel - japonská stěna (750x443)



Čelní panel - zirconio/dřevo (750x443)



REF. **4104000**

Čisté  
náklady

**2.679 Kč/Ks**

REF. **4194000**

**1.965 Kč/Ks**

Čelní panel - zirconio 28 mm (750x443)



Čelní panel - zirconio 20 mm (750x443)



REF. **4218000**

Čisté  
náklady

**2.163 Kč/Ks**

REF. **4219000**

**2.398 Kč/Ks**

Čelní panel - zirconio 20x20 mm (750x443)



REF. **4089000**

Čisté  
náklady

**2.789 Kč/Ks**

# Čelní panely "F" k vystavovacím vitrínám, 128 cm.

Čelní panel - kování 28 mm (994x600)



Čelní panel - kování 20 mm (994x600)



REF. **4203000**

Čisté  
náklady

**2.513 Kč/Ks**

**4202000**

**2.1525 Kč/Ks**

Čelní panel - dřevo 28-20 mm (994x600)



Čelní panel - rozpěrné kolejničky a vitrážky (994x600)



REF. **4204000**

Čisté  
náklady

**1.915 Kč/Ks**

**4205000**

**1.305 Kč/Ks**

Čelní panel - zirconio 20 mm (994x600)



REF. **4210000**

Čisté  
náklady

**2.521 Kč/Ks**

# Výstavné konstrukce, závěsné díly určené pro výstavní vitríny "F"

Výstavní vitrina "F", 800



Výstavní vitrina "F", 1280

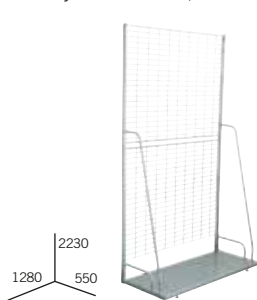

Výstavní vitrina 9 x 7, hluboká (53x53)

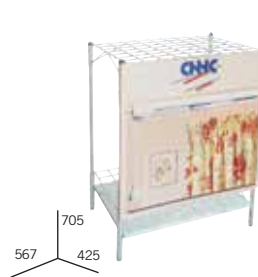

Nosný hák s plným úchytem pro vitríny "F"

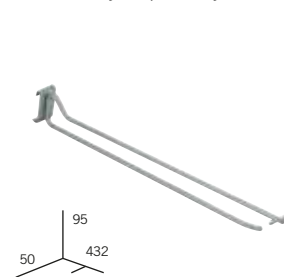

REF.	<b>1935320</b>	<b>1949320</b>	<b>4221000</b>	<b>1903320</b>
Čisté náklady	<b>7.387 Kč/Ks</b>	<b>11.474 Kč/Ks</b>	<b>3.115 Kč/Ks</b>	<b>93 Kč/Ks</b>

Jednoduchý hák pro vitríny "F"

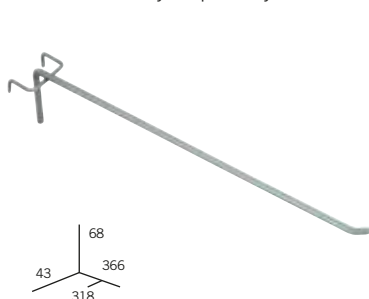

Oddělovač "F", horní, 2 kanály x 30 (pro tyče 12 - 28 mm)

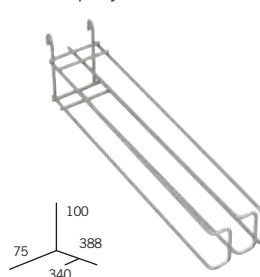

Oddělovač "F", spodní, 2 kanály x 30 (pro tyče 12 - 28 mm)

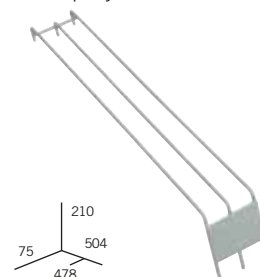

REF.	<b>1912320</b>	<b>1906320</b>	<b>1907320</b>
Čisté náklady	<b>55 Kč/Ks</b>	<b>294 Kč/Ks</b>	<b>231 Kč/Ks</b>

Oddělovač "F", horní, 4 kanály x 30 (pro tyče 12 - 28 mm)

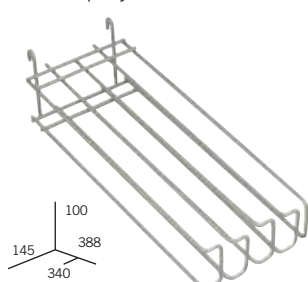

Oddělovač "F", spodní, 4 kanály x 30 (pro tyče 12 - 28 mm)

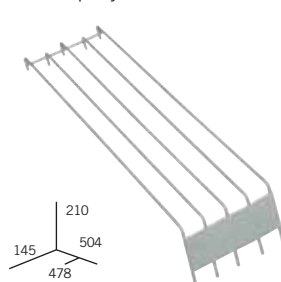

Oddělovač "F", horní, 4 kanály x 42 (Pro tyč 35 a blister 12 mm)

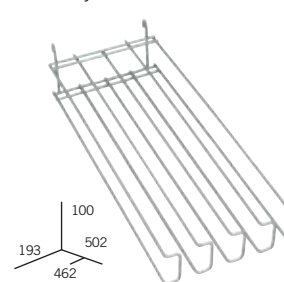

REF.	<b>1904320</b>	<b>1905320</b>	<b>1936320</b>
Čisté náklady	<b>403 Kč/Ks</b>	<b>311 Kč/Ks</b>	<b>406 Kč/Ks</b>

Oddělovač "F", spodní, 4 kanály x 42 (Pro tyč 35 a blister 12 mm)

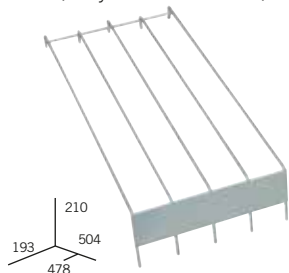

Oddělovač "F", horní, 2 kanály x 57 (pro blister 20 a 28 mm)

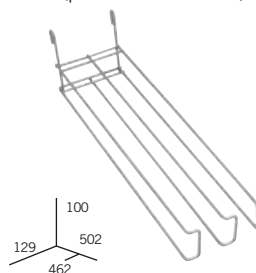

Oddělovač "F", spodní, 2 kanály x 57 (pro blister 20 a 28 mm)

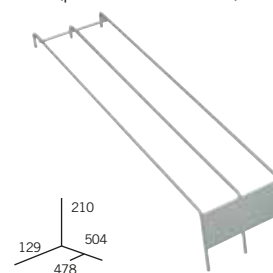

REF.	<b>1937320</b>	<b>1910320</b>	<b>1911320</b>
Čisté náklady	<b>331 Kč/Ks</b>	<b>303 Kč/Ks</b>	<b>342 Kč/Ks</b>

## Závěsné díly určené pro výstavní vitríny "F"

Oddělovač "F", horní, 3 kanály x 57  
(pro blister 20 a 28 mm)

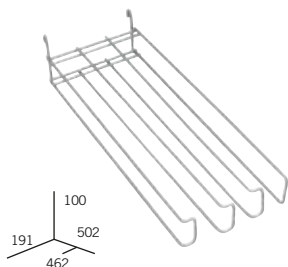

Oddělovač "F", spodní, 3 kanály x 57  
(pro blister 20 a 28 mm)

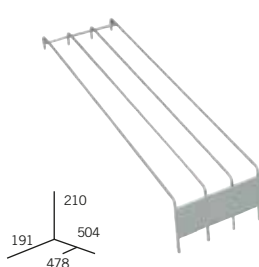

Oddělovač "F", horní, 4 kanály x 57  
(pro blister 20 a 28 mm)

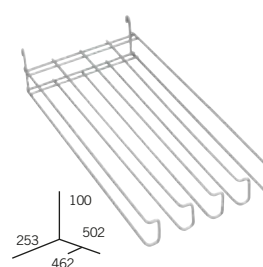

REF.	<b>220320</b>	<b>220330</b>	<b>190830</b>
Čisté náklady	<b>400 Kč/Ks</b>	<b>308 Kč/Ks</b>	<b>417 Kč/Ks</b>

Oddělovač "F", spodní, 4 kanály x 57  
(pro blister 20 a 28 mm)

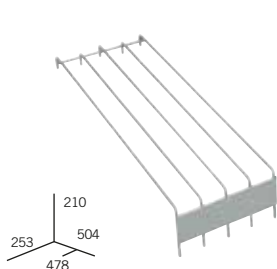

Oddělovač "F", horní, 3 kanály  
PJ x 67+85+103

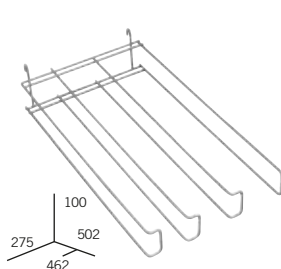

Oddělovač "F", spodní, 3 kanály  
PJ x 67+85+103

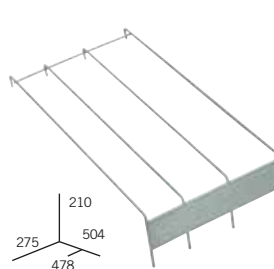

REF.	<b>1909320</b>	<b>1994320</b>	<b>1995320</b>
Čisté náklady	<b>332 Kč/Ks</b>	<b>405 Kč/Ks</b>	<b>321 Kč/Ks</b>

## Oddělovače "G" pro děrované panely a tyče

Oddělovač "G", horní, 2 kanály x 30  
(pro tyče 12-28 mm)

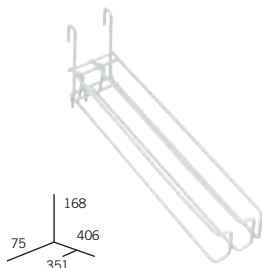

Oddělovač "G", spodní, 2 kanály x 30  
(pro tyče 12-28 mm)

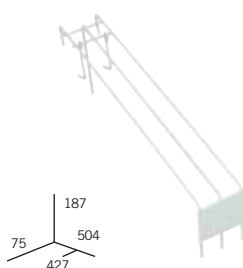

Oddělovač "G", horní, 3 kanály x 30  
(pro tyče 12-28 mm)

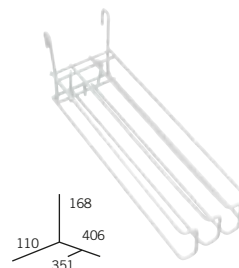

REF.	<b>1274060</b>	<b>1275060</b>	<b>2210060</b>
Čisté náklady	<b>281 Kč/Ks</b>	<b>232 Kč/Ks</b>	<b>429 Kč/Ks</b>

Oddělovač "G", spodní, 3 kanály x 30  
(pro tyče 12-28 mm)

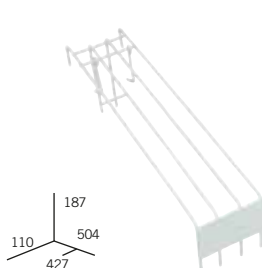

Oddělovač "G", horní, 4 kanály x 30  
(pro tyče 12-28 mm)

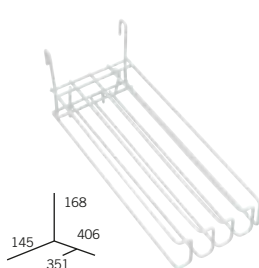

Oddělovač "G", spodní, 4 kanály x 30  
(pro tyče 12-28 mm)

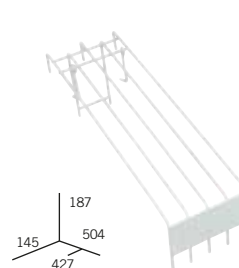

REF.	<b>2211060</b>	<b>1034060</b>	<b>1035060</b>
Čisté náklady	<b>438 Kč/Ks</b>	<b>480 Kč/Ks</b>	<b>349 Kč/Ks</b>



# Oddělovače "G" pro děrované panely a tyče

Oddělovač "G", horní, 16 kanály x 30  
(pro tyče 12 mm)

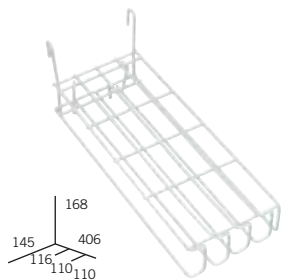

Oddělovač "G", spodní, 16 kanály x 30  
(pro tyče 12 mm)

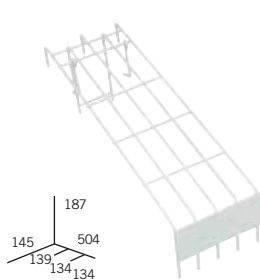

Oddělovač "G", horní, 4 kanály x 42  
(Pro tyč 35 a blister 12 mm)

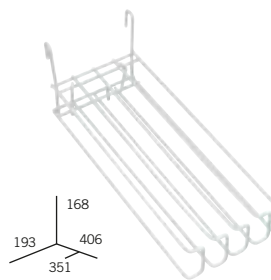

REF.	<b>1036060</b>	<b>1037060</b>	<b>2212060</b>
Čisté náklady	<b>504 Kč/Ks</b>	<b>349 Kč/Ks</b>	<b>537 Kč/Ks</b>

Oddělovač "G", spodní, 4 kanály x 42  
(Pro tyč 35 a blister 12 mm)

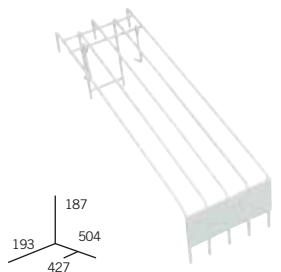

Oddělovač "G", horní, 2 kanály x 57  
(pro blister 20 a 28 mm)

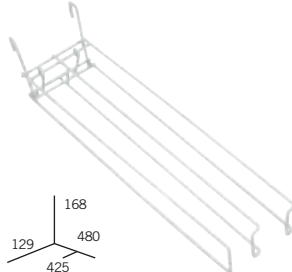

Oddělovač "G", spodní, 2 kanály x 57  
(pro blister 20 a 28 mm)

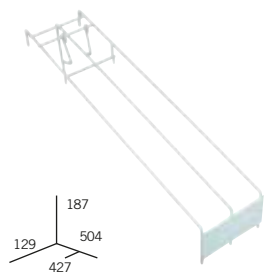

REF.	<b>2213060</b>	<b>1040060</b>	<b>1041060</b>
Čisté náklady	<b>373 Kč/Ks</b>	<b>453 Kč/Ks</b>	<b>349 Kč/Ks</b>

Oddělovač "G", horní, 3 kanály x 57  
(pro blister 20 a 28 mm)

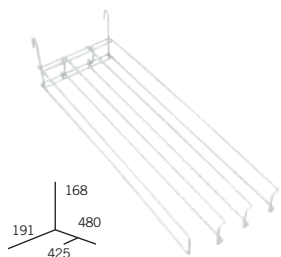

Oddělovač "G", spodní, 3 kanály x 57  
(pro blister 20 a 28 mm)

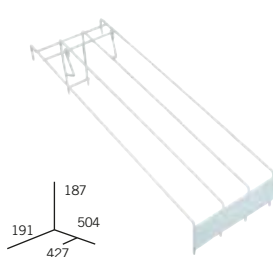

Oddělovač "G", horní, 4 kanály x 57  
(pro blister 20 a 28 mm)

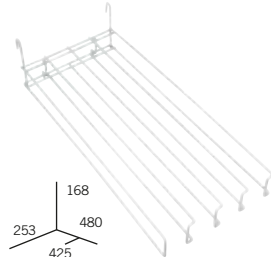

REF.	<b>2214060</b>	<b>2215060</b>	<b>1038060</b>
Čisté náklady	<b>457 Kč/Ks</b>	<b>461 Kč/Ks</b>	<b>493 Kč/Ks</b>

Oddělovač "G", spodní, 4 kanály x 57  
(pro blister 20 a 28 mm)

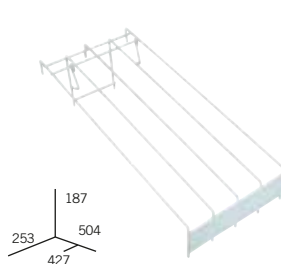

Oddělovač "G", horní, 3 kanály  
PJ x 67+85+103

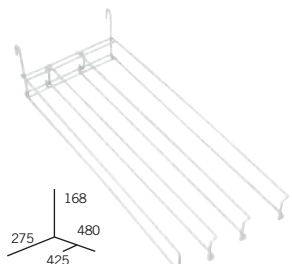

Oddělovač "G", spodní, 3 kanály  
PJ x 67+85+103

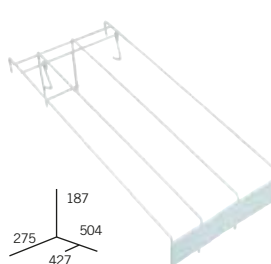

REF.	<b>1039060</b>	<b>2206060</b>	<b>2207060</b>
Čisté náklady	<b>356 Kč/Ks</b>	<b>400 Kč/Ks</b>	<b>403 Kč/Ks</b>



# HOJAS — *de* PEDIDO







Poligino Industrial "El Foreguer" s.m  
03460 BENEIXAMA (Alicante)

902 411 111  
FAX 902 411 110

Web: <http://www.rielchyc.com>  
E-mail: [rielchyc@rielchyc.com](mailto:rielchyc@rielchyc.com)

# PANEL TRACK PANEL TRACK WITH ROMAN BLIND

Date: \_\_\_\_\_ Customer ref.: \_\_\_\_\_

Customer: \_\_\_\_\_

Delivery address: \_\_\_\_\_

Town: \_\_\_\_\_ C.P.: \_\_\_\_\_

Contact phone number: \_\_\_\_\_ FAX \_\_\_\_\_

CONTACT US: 902 411 111

FAX FOR ORDER: 902 411 110

e-mail: [rielchyc@rielchyc.com](mailto:rielchyc@rielchyc.com)

REFERENCE	QTY.	HOW MANY CHANNELS?	PROFILE LENGTH CM.	TYPE (A, B, ...)	CORD DROP CM. (1)	OPERATING CORD		HOW MANY PANELS?	PANEL WIDTH CM. (2)	STACKING WAYS				ROMAN BLIND TYPE (3)
						LEFT	RIGHT			LEFT	RIGHT	CENTRE	PAIR	
						<input type="checkbox"/>	<input type="checkbox"/>			<input type="checkbox"/>	<input type="checkbox"/>	<input type="checkbox"/>	<input type="checkbox"/>	
						<input type="checkbox"/>	<input type="checkbox"/>			<input type="checkbox"/>	<input type="checkbox"/>	<input type="checkbox"/>	<input type="checkbox"/>	
						<input type="checkbox"/>	<input type="checkbox"/>			<input type="checkbox"/>	<input type="checkbox"/>	<input type="checkbox"/>	<input type="checkbox"/>	
						<input type="checkbox"/>	<input type="checkbox"/>			<input type="checkbox"/>	<input type="checkbox"/>	<input type="checkbox"/>	<input type="checkbox"/>	

(1) CORD STANDARD SYSTEM 200 cm

(2) NORMAL OVERLAP FOR PANELS IS 5 cm. IF OTHER MEASURE IS REQUIRED, OVERLAPS WILL BE MADE PROPORTIONAL.

(3) POSSIBLE ROMAN BLIND TYPES: COMPLETE AND PAQUETO

THE ALUMINIUM BOTTOM BAR IS 3 cm. SHORTER THAN THE SLIDING PANEL. IF DIFFERENT SIZES ARE REQUIRED, PLEASE SPECIFY IN ADDITIONAL INFORMATION !!

## STACKING WAYS



## SCHEMES

### UNCORDED EXAMPLES

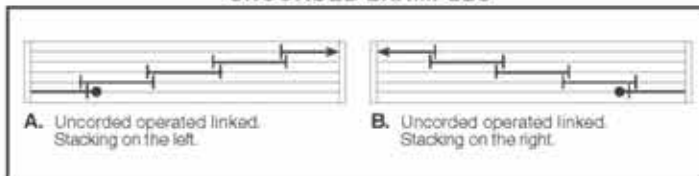

### CROSS CENTRE EXAMPLES

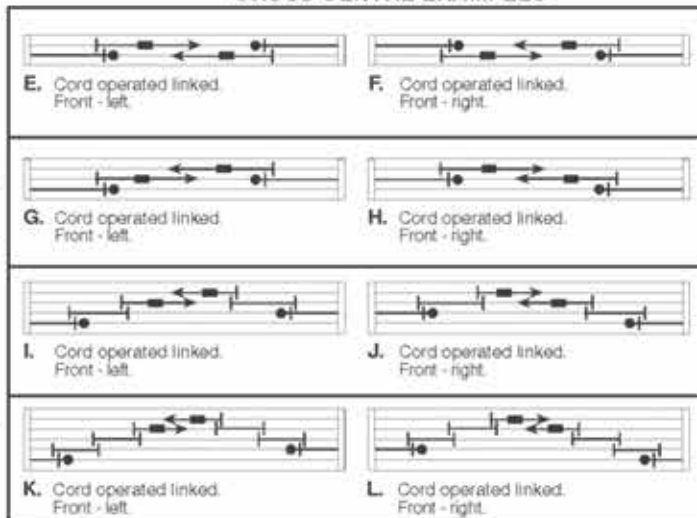

### CORD EXAMPLES

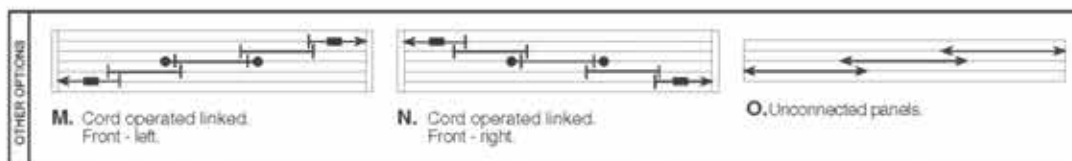
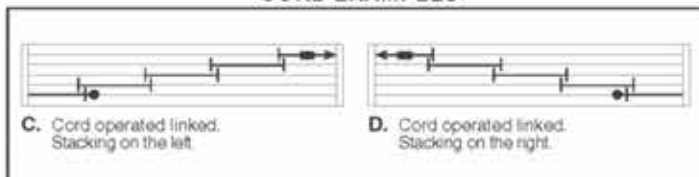

### KEY TO SYMBOLS

- Unconnected panels
- Uncorded & connected
- Corded & connected
- Fixed panels

Additional information:



Polígono Industrial "El Forseguer" s/n  
03460 BENEIXAMA (Alicante)

902 411 111  
FAX 902 411 110

Web: <http://www.rielchyc.com>  
E-mail: [rielchyc@rielchyc.com](mailto:rielchyc@rielchyc.com)

# PANEL JAPONÉS PANEL JAPONÉS CON ESTOR

Fecha:  Código Cliente:  N°Pedido

Cliente:

Dirección de envío:

Población:  C.P.:

Teléfono de contacto:  FAX

ATENCIÓN AL CLIENTE: 902 411 111

FAX para PEDIDOS: 902 411 110

e-mail: [rielchyc@rielchyc.com](mailto:rielchyc@rielchyc.com)

REFERENCIA	CANT.	Nº VIAS	LONGITUD TOTAL DEL PANEL EN CM.	LETRA DEL ESQUEMA	CAIDA DEL CORDÓN EN CM. (1)	MANDO CORDÓN		NÚMERO DE PORTATELAS	MEDIDA PORTATELAS EN CM. (2)	RECOGIDA				TIPO DE ESTOR (3)
						IZDA	DCHA			Izda	Dcha	Centro	Simétr	
						<input type="checkbox"/>	<input type="checkbox"/>			<input type="checkbox"/>	<input type="checkbox"/>	<input type="checkbox"/>	<input type="checkbox"/>	
						<input type="checkbox"/>	<input type="checkbox"/>			<input type="checkbox"/>	<input type="checkbox"/>	<input type="checkbox"/>	<input type="checkbox"/>	
						<input type="checkbox"/>	<input type="checkbox"/>			<input type="checkbox"/>	<input type="checkbox"/>	<input type="checkbox"/>	<input type="checkbox"/>	
						<input type="checkbox"/>	<input type="checkbox"/>			<input type="checkbox"/>	<input type="checkbox"/>	<input type="checkbox"/>	<input type="checkbox"/>	

(1) CAIDA DEL CORDÓN: SI NO SE ESPECIFICA, SE HARÁ DE 200 cms.

(2) EL SOLAPE NORMAL ES DE 5 cm. ENTRE PANELES. SI SE ESPECIFICA OTRA MEDIDA, LOS SOLAPES SE HARAN PROPORCIONALMENTE.

(3) TIPOS DE ESTORES POSIBLES: PLEGABLE COMPLETO y PAQUETO.

¡¡ LA PLETINA DE CONTRAPESO SE CORTARÁ 3 cm. MAS CORTA QUE EL PORTATELAS, A NO SER QUE SE ESPECIFIQUE OTRA COSA EN OBSERVACIONES !!

## ESQUEMAS

### FORMAS DE RECOGIDA

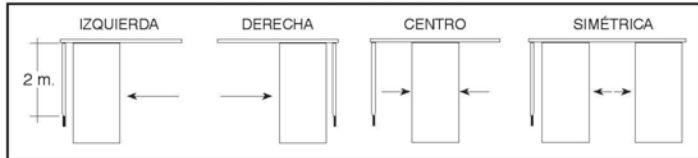

### EJEMPLO SIN CORDÓN

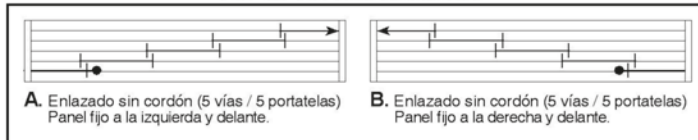

### EJEMPLO CON CORDÓN

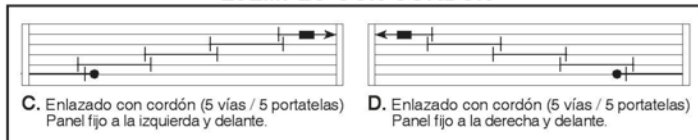

### EJEMPLO CRUCE CENTRO

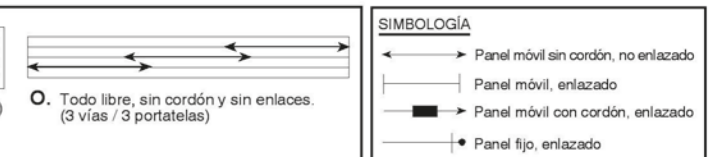
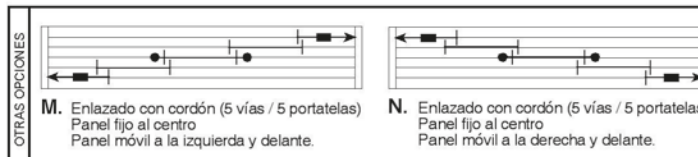
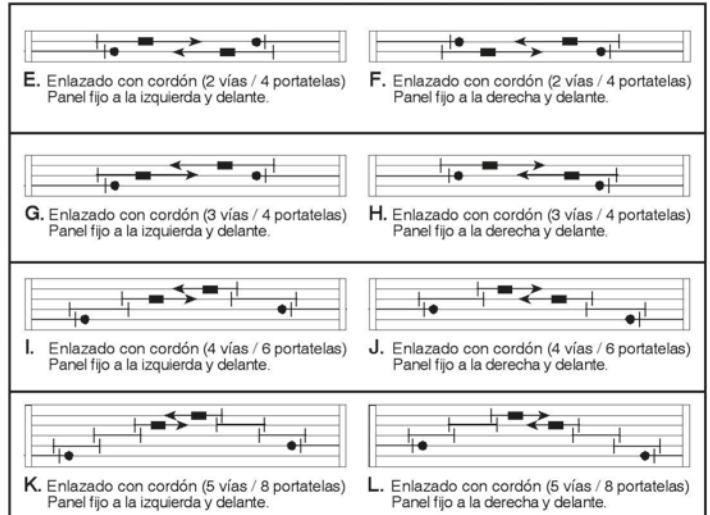

### Observaciones



Poligono Industrial "El Forseguer" s/n  
03460 BENEIXAMA (Alicante)

902 411 111  
FAX 902 411 110

Web: <http://www.rielchyc.com>  
E-mail: [rielchyc@rielchyc.com](mailto:rielchyc@rielchyc.com)

# CORNICES ORDER FORM

Date: \_\_\_\_\_

Customer ref.: \_\_\_\_\_

Customer: \_\_\_\_\_

Delivery address: \_\_\_\_\_

Town: \_\_\_\_\_

Post code: \_\_\_\_\_

Contact phone number: \_\_\_\_\_

Fax: \_\_\_\_\_

CONTACT US: 902 411 111

FAX FOR ORDER: 902 411 110

e-mail: [rielchyc@rielchyc.com](mailto:rielchyc@rielchyc.com)

REFERENCE	QTY.	PELMET COLOUR	INTERIOR LENGHT (cm.)	INTERIOR DEPTH (cm.)	PELMET TYPE	QUANTITY ACCESSORIES					
						CORNER JOINT	JOINING PIECE	LATERAL FINISH	CORNER PIECE	CORNICE BRACKET	COLOUR

MOULDING MAXIMUM LENGTH WITHOUT JOINT WILL BE 3,60 METRES.

Stándar quantity of squares will be the following (if a different quantity is required please indicate):

Number of squares:

- To 1,50 metres: 2 units
- Between 1,51 and 2,50: 3 units
- Between 2,51 and 3,60: 4 units
- More than 3,60: each piece, according to previous quantities.

If cornice is longer than 3,60 metres, a joint is necessary. If there is a central joint or more, front pieces will be the same.

MOULDING COLOURS: Wengue (10), Cherry-tree colour (11), White (06), Ash colour (12), Silver (40) & Unfinished (00).

ACCESSORIES COLOURS: Chromed (43), Matt nickel (42), Gold (24), Graphite (70) & Antique brass (47).

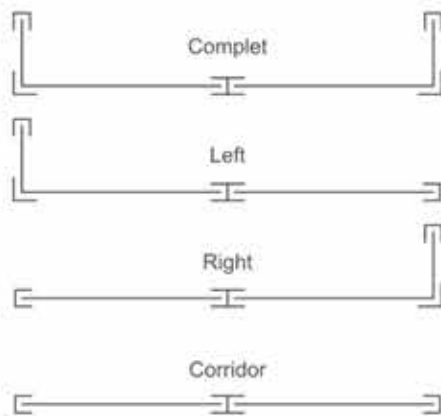

PELMET TYPE

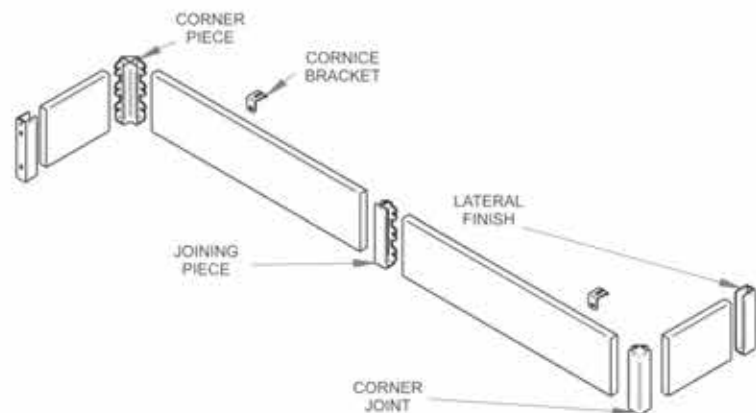
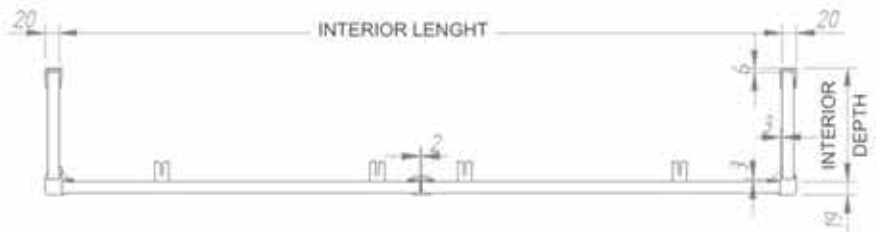

Additional information:

# HOJA DE PEDIDO - GALERÍAS



Polígono Industrial "El Forseguer" s/n  
03460 BENEIXAMA (Alicante)

902 411 111  
FAX 902 411 110

Web: <http://www.rielchyc.com>  
E-mail: [rielchyc@rielchyc.com](mailto:rielchyc@rielchyc.com)

Fecha: \_\_\_\_\_

Código Cliente: \_\_\_\_\_

Cliente: \_\_\_\_\_

Dirección de envío: \_\_\_\_\_

Población: \_\_\_\_\_ C.P.: \_\_\_\_\_

Teléfono de contacto: \_\_\_\_\_ FAX: \_\_\_\_\_

ATENCIÓN AL CLIENTE: 902 411 111

FAX para PEDIDOS: 902 411 110

e-mail: [rielchyc@rielchyc.com](mailto:rielchyc@rielchyc.com)

REFERENCIA	CANT.	COLOR MOLDURA	LONGITUD INTERIOR (cm)	PROFUNDIDAD INTERIOR (cm)	TIPO DE GALERÍA	Cantidad de ACCESORIOS					
						Unión Esquina	Empalme Galería	Remate Lateral	Rinconera	Escuadra	Color

LA LONGITUD MAXIMA DE LA MOLDURA SIN EMPALMES SERA DE 3,60 METROS.

La cantidad estándar de ESCUADRAS será la siguiente ( si se quiere otra cantidad, INDICAR ):

Nº Escuadras:

- Hasta 1,50 metros: 2 unidades
- De 1,51 a 2,50: 3 unidades
- De 2,51 a 3,60: 4 unidades
- Más de 3,60: Cada trozo, según las cantidades anteriores.

Si la galería es mayor de 3,60 metros, debe ir con empalme. Siempre que haya un empalme central o más, se harán los trozos delanteros iguales.

COLORES MOLDURA: Wengué (10), Cerezo (11), Blanco (06), Ceniza (12), Plata (40) y Crudo (00).

COLORES ACCESORIOS: Cromo (43), Níquel Mate (42), Oro (24), Grafito (70) y Bronce Viejo (47).

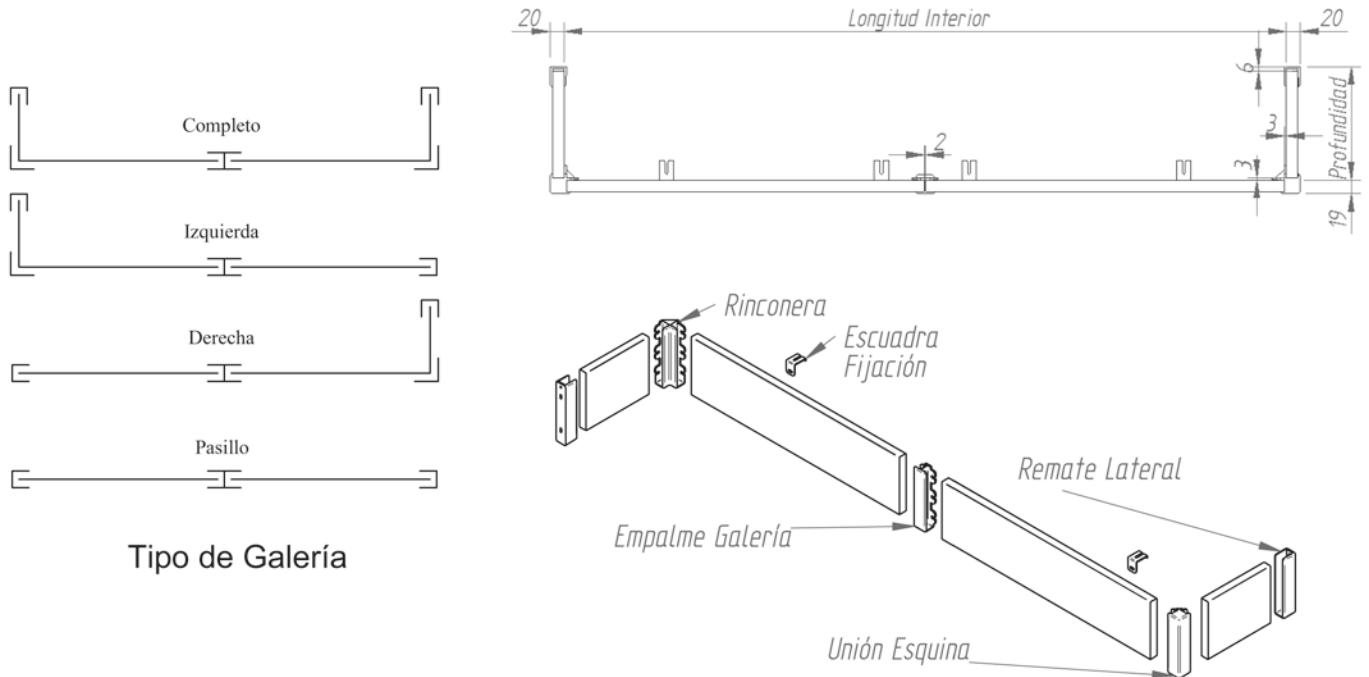

Observaciones/Esquemas:



Poligono Industrial "El Foguear" s/n  
03460 BENEIXAMA (Alicante)

902 411 111  
FAX 902 411 110

Web: <http://www.rielchyc.com>  
E-mail: [rielchyc@rielchyc.com](mailto:rielchyc@rielchyc.com)

## ROMAN BLIND MADE TO MEASURE ORDER FORM

Date: \_\_\_\_\_ Customer ref.: \_\_\_\_\_

Customer: \_\_\_\_\_

Delivery address: \_\_\_\_\_

Town: \_\_\_\_\_ Post code: \_\_\_\_\_

Contact phone number: \_\_\_\_\_ Fax: \_\_\_\_\_

CONTACT US: 902 411 111

FAX FOR ORDER: 902 411 110

e-mail: [rielchyc@rielchyc.com](mailto:rielchyc@rielchyc.com)

REFERENCE	QTY.	ROMAN BLIND TYPE (A, B,...)	TOTAL WIDTH (cm.)	TOTAL LENGTH (cm.)	SYSTEM		QTY.: CORD GUIDES REELS BRACKETS (*)	TRANSP. TAPES (YES/NO)	TRANSP. ALUM. BOTTOM BAR (YES/NO)	CONFIGURATION			
					LEFT	RIGHT				COMPLETE	WITHOUT THREAD TAPES	COMPLETE WITH PAQUETO TAPE	WITHOUT FIBREGLASS RODS AND WITHOUT THREAD TAPES
					<input type="checkbox"/>	<input type="checkbox"/>				<input type="checkbox"/>	<input type="checkbox"/>	<input type="checkbox"/>	<input type="checkbox"/>
					<input type="checkbox"/>	<input type="checkbox"/>				<input type="checkbox"/>	<input type="checkbox"/>	<input type="checkbox"/>	<input type="checkbox"/>
					<input type="checkbox"/>	<input type="checkbox"/>				<input type="checkbox"/>	<input type="checkbox"/>	<input type="checkbox"/>	<input type="checkbox"/>
					<input type="checkbox"/>	<input type="checkbox"/>				<input type="checkbox"/>	<input type="checkbox"/>	<input type="checkbox"/>	<input type="checkbox"/>
					<input type="checkbox"/>	<input type="checkbox"/>				<input type="checkbox"/>	<input type="checkbox"/>	<input type="checkbox"/>	<input type="checkbox"/>
					<input type="checkbox"/>	<input type="checkbox"/>				<input type="checkbox"/>	<input type="checkbox"/>	<input type="checkbox"/>	<input type="checkbox"/>

(\*) STANDARD COMPONENTS WILL BE PLACE IF IT IS NOT SPECIFIED.

!!! THE ALUMINIUM BOTTOM BAR AND FIBREGLASS RODS ARE 3 cm. SHORTER THAN THE SLIDING PANEL. IF DIFFERENT SIZES ARE REQUIRED, PLEASE SPECIFY IN ADDITIONAL INFORMATION !!

ROMAN BLIND TYPES	STANDARD COMPONENTS
<p>A. Cord-locking system, profile 864.</p> <p>B. Geared side-winding system, profile 864 (Fast).</p> <p>C. Geared side-winding system, profile 864 (Slow).</p> <p>D. Cord-locking system, profile 7206.</p> <p>E. Side-winding system, profile 7206.</p> <p>F. Cord-locking system, profile 942.</p> <p>G. Geared side-winding system, profile 942.</p> <p>H. Compact blind system.</p>	<p>Quantity: Cord guides, reels &amp; brackets:</p> <ul style="list-style-type: none"> <li>- To 1.20 m. : 2 units.</li> <li>- Between 1.21 &amp; 2.10 m.: 3 units.</li> <li>- More than 2.10 m.: 4 units.</li> </ul> <p>1 fibreglass rods Ø4 with end-caps for each 30 cm length 1 aluminium bottom bar with end-caps.</p> <p>EVERY ADDITIONAL COMPONENTS WILL BE INVOICE BY PRICE LIST</p>

COMPONENTS							
	Mechanisms	Aluminium bottom bar	Fibreglass rods	Loop tape	Finial ring	Paqueto tape	Roman blind thread tape
COMPLETE	YES	YES	YES	YES	YES	-	YES
WITHOUT THREAD TAPES	YES	YES	YES	-	-	-	-
COMPLETE W/PAQUETO TAPE	YES	YES	-	YES	YES	YES	-
WITHOUT THREAD TAPES & WITHOUT FIBREGLASS RODS	YES	YES	-	-	-	-	-

Additional information:



☒ Polligino Industrial "El Forseguer" s/n  
03460 BENEIXAMA (Alicante)

☎ 902 411 111  
FAX 902 411 110

Web: <http://www.rielchyc.com>  
E-mail: [rielchyc@rielchyc.com](mailto:rielchyc@rielchyc.com)

## HOJA DE PEDIDO ESTORES A MEDIDA

Fecha:  Código Cliente:

Cliente:

Dirección de envío:

Población:  C.P.:

Teléfono de contacto:  FAX:

ATENCIÓN AL CLIENTE: 902 411 111

FAX para PEDIDOS: 902 411 110

e-mail: [rielchyc@rielchyc.com](mailto:rielchyc@rielchyc.com)

REF.	CANT	TIPO ESTOR (A,B,C..)	ANCHO TOTAL (CM)	ALTO TOTAL (CM.)	MANDO		Nº GUIA-HILOS CARRETES SOPORTES (*)	CINTAS TRANSP. (SI/NO)	PLETINA TRANSP. (SI/NO)	CONFIGURACION			
					IZDA	DCHA				Plegable Completo	Plegable sin cintas	Paquete completo	Estor sin cintas ni varillas
					<input type="checkbox"/>	<input type="checkbox"/>				<input type="checkbox"/>	<input type="checkbox"/>	<input type="checkbox"/>	<input type="checkbox"/>
					<input type="checkbox"/>	<input type="checkbox"/>				<input type="checkbox"/>	<input type="checkbox"/>	<input type="checkbox"/>	<input type="checkbox"/>
					<input type="checkbox"/>	<input type="checkbox"/>				<input type="checkbox"/>	<input type="checkbox"/>	<input type="checkbox"/>	<input type="checkbox"/>
					<input type="checkbox"/>	<input type="checkbox"/>				<input type="checkbox"/>	<input type="checkbox"/>	<input type="checkbox"/>	<input type="checkbox"/>
					<input type="checkbox"/>	<input type="checkbox"/>				<input type="checkbox"/>	<input type="checkbox"/>	<input type="checkbox"/>	<input type="checkbox"/>
					<input type="checkbox"/>	<input type="checkbox"/>				<input type="checkbox"/>	<input type="checkbox"/>	<input type="checkbox"/>	<input type="checkbox"/>

¡ LA PLETINA DE CONTRAPESO Y LAS VARILLAS SE CORTAN 3 cm. MAS CORTAS QUE EL PERFIL, A NO SER QUE SE ESPECIFIQUE EN OBSERVACIONES !  
\* : SI NO SE ESPECIFICA, SE PONDRÁN LOS COMPONENTES ESTANDAR.

Tipos de estores	Componentes Estándar
A. Perfil 864 Hilo. B. Perfil 864 Cadenilla Reducción Rápida. C. Perfil 864 Cadenilla Reducción Lenta. D. Perfil 7206 Hilo. E. Perfil 7206 Cadenilla. F. Perfil 942 Hilos. G. Perfil 942 Cadenilla. H. Estor Compacto.	Nº de Guía Hilos, carretes y soportes: - Hasta 1,20: 2 unidades. - Entre 1,21 y 2,10 m: 3 unidades. - Más de 2,10 m: 4 unidades. 1 varilla poliester de Ø4 con tapones por cada 30 cm de alto. 1 Pletina contrapeso con tapones <b>Todos los componentes adicionales se facturarán a precio de tarifa.</b>

COMPONENTES							
	Mecanismos	Pletina Contrap.	Varillas	Cinta Felpa	Anilla Final	Cinta paquete	Cinta Estor
Plegable Completo	SÍ	SÍ	SÍ	SÍ	SÍ	-	SÍ
Plegable sin cintas	SÍ	SÍ	SÍ		-	-	-
Paquete Completo	SÍ	SÍ	-	SÍ	SÍ	SÍ	-
Estor sin cintas ni varillas	SÍ	SÍ	-	-	-	-	-

### Observaciones





Poligino Industrial "El Forseguer" s/n  
 03460 BENEIXAMA (Alicante)  
 902 411 111  
 FAX 902 411 110  
 Web: <http://www.rielchyc.com>  
 E-mail: [rielchyc@rielchyc.com](mailto:rielchyc@rielchyc.com)

# ROLLER BLIND ORDER FORM

Date:  Customer ref.:

Customer:

Delivery address:

Town:  Post code:

Contact phone number:  Fax:

CONTACT US: 902 411 111

FAX FOR ORDER: 902 411 110

e-mail: [rielchyc@rielchyc.com](mailto:rielchyc@rielchyc.com)

QTY.	FABRIC REF.	WIDHT (cm.)	LENGHT (cm.)	MECHANISM COLOUR (1)	ALUMINIUM BOTTOM BAR (2)			SYSTEM		ROLLER SYSTEM		COMPESATE SYSTEM (3)
					HIDDEN	VIEW	COLOUR	RIGHT	LEFT	BACK	FRONT	
					<input type="checkbox"/>	<input type="checkbox"/>		<input type="checkbox"/>	<input type="checkbox"/>	<input type="checkbox"/>	<input type="checkbox"/>	
					<input type="checkbox"/>	<input type="checkbox"/>		<input type="checkbox"/>	<input type="checkbox"/>	<input type="checkbox"/>	<input type="checkbox"/>	
					<input type="checkbox"/>	<input type="checkbox"/>		<input type="checkbox"/>	<input type="checkbox"/>	<input type="checkbox"/>	<input type="checkbox"/>	
					<input type="checkbox"/>	<input type="checkbox"/>		<input type="checkbox"/>	<input type="checkbox"/>	<input type="checkbox"/>	<input type="checkbox"/>	

## SPECIFICATIONS

**MEASURES** (Take measures from some different points and choose the smaller one)

- Roman blind width will be the same that the maximum measure of the hole where it will be placed, less 1 cm.
- Lenght will correspond with the maximum lenght of the hole where it will be placed, less 0.5 cm.

We may bear in mind that the fabric width will be measure 4 cm. less than the mechanism. We mean; if you order a 125 cm. widht roman blind, fabric will really measure  $124 - 4 = 121$  cm.

- (1) **MECHANISM COLOURS:** Available colours are: standard white, black, grey, yellow, red, light blue, brown and orange.  
 (2) **COMPENSATE SYSTEM:** Standard compensate system is hidden (tear kind). If view is required, colour must be specified.  
 Available colours for view compensate system are: standard white, brass and silver.

### CHAIN FALL

- Lenght less than 1.5 metres: 1000 mm.
- Lenght between 1.51 and 2.00: 1500 mm.
- Lenght more than 2.01: 2000 mm.

- (3) **NOTE:** Roman blind kits more than 3 meters width will always have a spring compensate system.

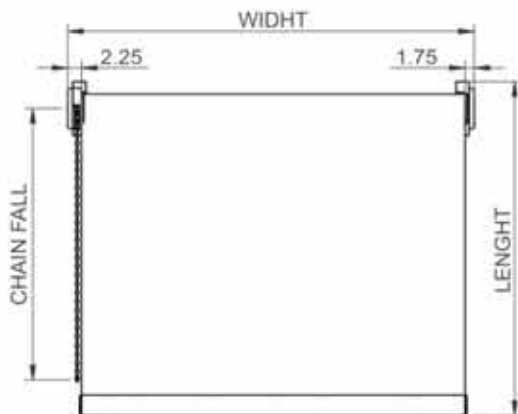

### Roller system

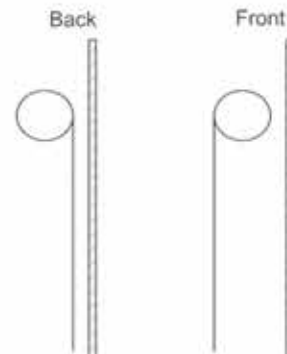

Additional information:

# HOJA DE PEDIDO - ESTOR ENROLLABLE



Polígono Industrial "El Forseguer" s/n  
03460 BENEIXAMA (Alicante)

902 411 111  
FAX 902 411 110

Web: <http://www.rielchyc.com>  
E-mail: [rielchyc@rielchyc.com](mailto:rielchyc@rielchyc.com)

Fecha:  Código Cliente:

Cliente:

Dirección de envío:

Población:  C.P.:

Teléfono de contacto:  FAX:

ATENCIÓN AL CLIENTE: 902 411 111

FAX para PEDIDOS: 902 411 110

e-mail: [rielchyc@rielchyc.com](mailto:rielchyc@rielchyc.com)

CANT.	REF.TEJIDO	ANCHO en CM. ↔	ALTO en CM. ↕	COLOR MECANISMOS (1)	TIPO Y COLOR CONTRAPESO (2)			MANDO		TIPO DE ENROLLADO		MECANISMO COMPENSADOR (Si/No) (3)
					Oculto	Visto	COLOR	DCHA	IZDA.	Trasero	Delantero	
					<input type="checkbox"/>	<input type="checkbox"/>		<input type="checkbox"/>	<input type="checkbox"/>	<input type="checkbox"/>	<input type="checkbox"/>	
					<input type="checkbox"/>	<input type="checkbox"/>		<input type="checkbox"/>	<input type="checkbox"/>	<input type="checkbox"/>	<input type="checkbox"/>	
					<input type="checkbox"/>	<input type="checkbox"/>		<input type="checkbox"/>	<input type="checkbox"/>	<input type="checkbox"/>	<input type="checkbox"/>	
					<input type="checkbox"/>	<input type="checkbox"/>		<input type="checkbox"/>	<input type="checkbox"/>	<input type="checkbox"/>	<input type="checkbox"/>	

## ESPECIFICACIONES

**MEDIDAS** ( tomar la medida en varios puntos y coger la más pequeña ):

- El ancho del estor a especificar se corresponderá con la medida máxima del hueco donde deba ir, menos 1 cm.
- El alto del estor a especificar se corresponderá con la altura máxima del hueco donde deba ir, menos 0,5 cm.

Hay que tener en cuenta, que el ancho de la tela será 4 cm. menor que el mecanismo, es decir, que si nos pidieran un estor de 125 cm. de ancho, la tela sería realmente de  $125 - 4 = 121$  cm

(1) **COLORES MECANISMOS**: Los colores disponibles son: Blanco ( ESTÁNDAR), Negro, Gris, Amarillo, Rojo, Azul Claro, Marrón y Naranja.

(2) **CONTRAPESO**: El contrapeso ESTANDAR es oculto de tipo "LAGRIMA". Si se especifica "Visto" Habrá que especificar también el color. Los colores disponibles para el contrapeso "Visto" son: Blanco ( ESTÁNDAR), Bronce y Plata.

### CAIDA DE LA CADENILLA

Alto menor de 1,5 metros: 1000 mm.

Alto entre 1,51 y 2,00 : 1500 mm.

Alto mayor de 2,01: 2000 mm.

(3) **NOTA**: Los estores de más de 3 m<sup>2</sup> llevarán siempre el mecanismo compensador de muelle.

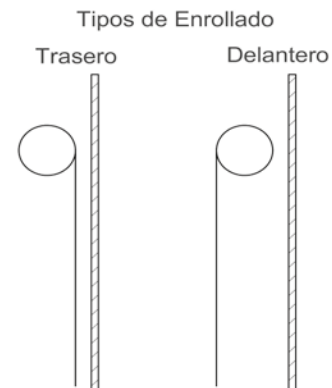
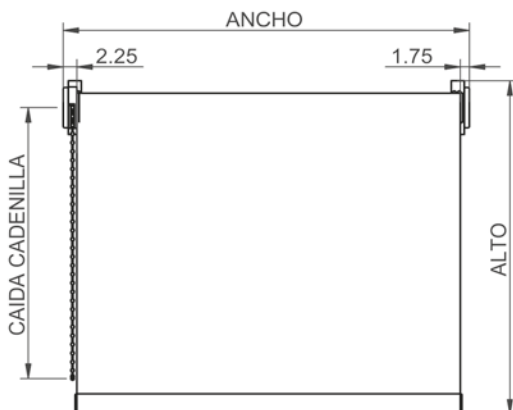

### Observaciones



Poligono Industrial "El Forseguer" s/n  
03460 BENEIXAMA (Alicante)

902 411 111  
FAX 902 411 110

Web: <http://www.rielchyc.com>  
E-mail: [rielchyc@rielchyc.com](mailto:rielchyc@rielchyc.com)

## STEEL TRACK MADE TO MEASURE ORDER FORM

Date: \_\_\_\_\_ Customer ref.: \_\_\_\_\_

Customer: \_\_\_\_\_

Delivery address: \_\_\_\_\_

Town: \_\_\_\_\_ Post code: \_\_\_\_\_

Contact phone number: \_\_\_\_\_ Fax: \_\_\_\_\_

CONTACT US: 902 411 111

FAX FOR ORDER: 902 411 110

e-mail: [rielchyc@rielchyc.com](mailto:rielchyc@rielchyc.com)

REFERENCE (*)	QTY.	TOTAL WIDHT (cm.)	STEEL TRACK TYPE		SYSTEM					STACKING WAYS			
			FACE-FIX	TOP-FIX	UNCORDED	LEFT CORD	RIGHT CORD	DOUBLE CORD	CORD FALL (cm.)	LEFT	RIGHT	PAIR	
			<input type="checkbox"/>	<input type="checkbox"/>	<input type="checkbox"/>	<input type="checkbox"/>	<input type="checkbox"/>	<input type="checkbox"/>	<input type="checkbox"/>		<input type="checkbox"/>	<input type="checkbox"/>	<input type="checkbox"/>
			<input type="checkbox"/>	<input type="checkbox"/>	<input type="checkbox"/>	<input type="checkbox"/>	<input type="checkbox"/>	<input type="checkbox"/>	<input type="checkbox"/>		<input type="checkbox"/>	<input type="checkbox"/>	<input type="checkbox"/>
			<input type="checkbox"/>	<input type="checkbox"/>	<input type="checkbox"/>	<input type="checkbox"/>	<input type="checkbox"/>	<input type="checkbox"/>	<input type="checkbox"/>		<input type="checkbox"/>	<input type="checkbox"/>	<input type="checkbox"/>
			<input type="checkbox"/>	<input type="checkbox"/>	<input type="checkbox"/>	<input type="checkbox"/>	<input type="checkbox"/>	<input type="checkbox"/>	<input type="checkbox"/>		<input type="checkbox"/>	<input type="checkbox"/>	<input type="checkbox"/>
			<input type="checkbox"/>	<input type="checkbox"/>	<input type="checkbox"/>	<input type="checkbox"/>	<input type="checkbox"/>	<input type="checkbox"/>	<input type="checkbox"/>		<input type="checkbox"/>	<input type="checkbox"/>	<input type="checkbox"/>
			<input type="checkbox"/>	<input type="checkbox"/>	<input type="checkbox"/>	<input type="checkbox"/>	<input type="checkbox"/>	<input type="checkbox"/>	<input type="checkbox"/>		<input type="checkbox"/>	<input type="checkbox"/>	<input type="checkbox"/>
			<input type="checkbox"/>	<input type="checkbox"/>	<input type="checkbox"/>	<input type="checkbox"/>	<input type="checkbox"/>	<input type="checkbox"/>	<input type="checkbox"/>		<input type="checkbox"/>	<input type="checkbox"/>	<input type="checkbox"/>
			<input type="checkbox"/>	<input type="checkbox"/>	<input type="checkbox"/>	<input type="checkbox"/>	<input type="checkbox"/>	<input type="checkbox"/>	<input type="checkbox"/>		<input type="checkbox"/>	<input type="checkbox"/>	<input type="checkbox"/>
			<input type="checkbox"/>	<input type="checkbox"/>	<input type="checkbox"/>	<input type="checkbox"/>	<input type="checkbox"/>	<input type="checkbox"/>	<input type="checkbox"/>		<input type="checkbox"/>	<input type="checkbox"/>	<input type="checkbox"/>
			<input type="checkbox"/>	<input type="checkbox"/>	<input type="checkbox"/>	<input type="checkbox"/>	<input type="checkbox"/>	<input type="checkbox"/>	<input type="checkbox"/>		<input type="checkbox"/>	<input type="checkbox"/>	<input type="checkbox"/>
			<input type="checkbox"/>	<input type="checkbox"/>	<input type="checkbox"/>	<input type="checkbox"/>	<input type="checkbox"/>	<input type="checkbox"/>	<input type="checkbox"/>		<input type="checkbox"/>	<input type="checkbox"/>	<input type="checkbox"/>
			<input type="checkbox"/>	<input type="checkbox"/>	<input type="checkbox"/>	<input type="checkbox"/>	<input type="checkbox"/>	<input type="checkbox"/>	<input type="checkbox"/>		<input type="checkbox"/>	<input type="checkbox"/>	<input type="checkbox"/>

(\*) FOR REFERENCES & PRICES IF YOU ORDER IN-BETWEEN SIZES THE HIGHER PRICE APPLIES  
NOTE: FOR DOUBLE CORDING SYSTEM ADD 10%.

### STANDARS COMPONENTS

**Quantity: Brackets:**

- To 1.00 m.: 2 units.
- Between 1.01 and 2.00 m.: 3 units.
- Between 2.01 and 3.50 m.: 4 units.
- More than 3.51 m.: 5 units.

(1) Standar cord fall: 1.75 m.

One simple runner per 10 cm. of track.

EVERY ADDITIONAL COMPONENTS WILL BE INVOICE BY PRICE LIST

Additional information:



Polígono Industrial "El Forseguer" s/n  
03460 BENEIXAMA (Alicante)

902 411 111  
FAX 902 411 110

Web: <http://www.rielchyc.com>  
E-mail: [rielchyc@rielchyc.com](mailto:rielchyc@rielchyc.com)

## HOJA DE PEDIDO - RIEL HIERRO LACADO

Fecha:  Código Cliente:

Cliente:

Dirección de envío:

Población:  C.P.:

Teléfono de contacto:  FAX:

ATENCIÓN AL CLIENTE: 902 411 111

FAX para PEDIDOS: 902 411 110

e-mail: [rielchyc@rielchyc.com](mailto:rielchyc@rielchyc.com)

REFERENCIA (*)	UNDS.	LONGITUD TOTAL DEL RIEL EN CM.	TIPO DE RIEL		MANDO				CAÍDA(CM) (1)	RECOGIDA		
			FRENTE	TECHO	SIN CORDON	CORDÓN IZDA.	CORDÓN DCHA.	CORDÓN DOBLE		IZDA.	DCHA.	SIMETR.
			<input type="checkbox"/>	<input type="checkbox"/>	<input type="checkbox"/>	<input type="checkbox"/>	<input type="checkbox"/>	<input type="checkbox"/>		<input type="checkbox"/>	<input type="checkbox"/>	<input type="checkbox"/>
			<input type="checkbox"/>	<input type="checkbox"/>	<input type="checkbox"/>	<input type="checkbox"/>	<input type="checkbox"/>	<input type="checkbox"/>		<input type="checkbox"/>	<input type="checkbox"/>	<input type="checkbox"/>
			<input type="checkbox"/>	<input type="checkbox"/>	<input type="checkbox"/>	<input type="checkbox"/>	<input type="checkbox"/>	<input type="checkbox"/>		<input type="checkbox"/>	<input type="checkbox"/>	<input type="checkbox"/>
			<input type="checkbox"/>	<input type="checkbox"/>	<input type="checkbox"/>	<input type="checkbox"/>	<input type="checkbox"/>	<input type="checkbox"/>		<input type="checkbox"/>	<input type="checkbox"/>	<input type="checkbox"/>
			<input type="checkbox"/>	<input type="checkbox"/>	<input type="checkbox"/>	<input type="checkbox"/>	<input type="checkbox"/>	<input type="checkbox"/>		<input type="checkbox"/>	<input type="checkbox"/>	<input type="checkbox"/>
			<input type="checkbox"/>	<input type="checkbox"/>	<input type="checkbox"/>	<input type="checkbox"/>	<input type="checkbox"/>	<input type="checkbox"/>		<input type="checkbox"/>	<input type="checkbox"/>	<input type="checkbox"/>
			<input type="checkbox"/>	<input type="checkbox"/>	<input type="checkbox"/>	<input type="checkbox"/>	<input type="checkbox"/>	<input type="checkbox"/>		<input type="checkbox"/>	<input type="checkbox"/>	<input type="checkbox"/>
			<input type="checkbox"/>	<input type="checkbox"/>	<input type="checkbox"/>	<input type="checkbox"/>	<input type="checkbox"/>	<input type="checkbox"/>		<input type="checkbox"/>	<input type="checkbox"/>	<input type="checkbox"/>
			<input type="checkbox"/>	<input type="checkbox"/>	<input type="checkbox"/>	<input type="checkbox"/>	<input type="checkbox"/>	<input type="checkbox"/>		<input type="checkbox"/>	<input type="checkbox"/>	<input type="checkbox"/>
			<input type="checkbox"/>	<input type="checkbox"/>	<input type="checkbox"/>	<input type="checkbox"/>	<input type="checkbox"/>	<input type="checkbox"/>		<input type="checkbox"/>	<input type="checkbox"/>	<input type="checkbox"/>
			<input type="checkbox"/>	<input type="checkbox"/>	<input type="checkbox"/>	<input type="checkbox"/>	<input type="checkbox"/>	<input type="checkbox"/>		<input type="checkbox"/>	<input type="checkbox"/>	<input type="checkbox"/>
			<input type="checkbox"/>	<input type="checkbox"/>	<input type="checkbox"/>	<input type="checkbox"/>	<input type="checkbox"/>	<input type="checkbox"/>		<input type="checkbox"/>	<input type="checkbox"/>	<input type="checkbox"/>
			<input type="checkbox"/>	<input type="checkbox"/>	<input type="checkbox"/>	<input type="checkbox"/>	<input type="checkbox"/>	<input type="checkbox"/>		<input type="checkbox"/>	<input type="checkbox"/>	<input type="checkbox"/>

(\*) CUANDO SE PIDAN MEDIDAS INTERMEDIAS A LAS ESTÁNDAR; SE APLICARÁ LA REFERENCIA Y PRECIO DE LA INMEDIATA SUPERIOR  
El Doble mando conlleva un recargo en precio de un 10%

### Componentes Estándar

Nº de soportes/estribos:

- Hasta 1,0 metros: 2 unidades
- Entre 1,01 y 2,00: 3 unidades
- Entre 2,01 y 3,50: 4 unidades
- Más de 3,51 metros: 5 unidades

(1) Caída del cordón estándar: 1,75 metros.

1 corredera simple por cada 10 cm. de riel

**Todos los componentes adicionales se facturarán a precio de tarifa.**

### Datos adicionales



Poligono Industrial "El Forseguer" s/n  
03460 BENEIXAMA (Alicante)  
902 411 111  
FAX 902 411 110  
Web: <http://www.rielchyc.com>  
E-mail: [rielchyc@rielchyc.com](mailto:rielchyc@rielchyc.com)

# ALUMINIUM TRACK MADE TO MEASURE ORDER FORM

Date: \_\_\_\_\_ Customer ref.: \_\_\_\_\_

Customer: \_\_\_\_\_

Delivery address: \_\_\_\_\_

Town: \_\_\_\_\_ Post code: \_\_\_\_\_

Contact phone number: \_\_\_\_\_ Fax: \_\_\_\_\_

CONTACT US: 902 411 111

FAX FOR ORDER: 902 411 110

e-mail: [rielchyc@rielchyc.com](mailto:rielchyc@rielchyc.com)

REFERENCE (*)	QTY.	TOTAL WIDHT (cm.)	ALUMINIUM TRACK TYPE		SYSTEM				STACKING WAYS		
			TYPE	MODALITY	LEFT	RIGHT	DOUBLE	CORD FALL (cm.)	LEFT	RIGHT	PAIR
					<input type="checkbox"/>	<input type="checkbox"/>	<input type="checkbox"/>		<input type="checkbox"/>	<input type="checkbox"/>	<input type="checkbox"/>
					<input type="checkbox"/>	<input type="checkbox"/>	<input type="checkbox"/>		<input type="checkbox"/>	<input type="checkbox"/>	<input type="checkbox"/>
					<input type="checkbox"/>	<input type="checkbox"/>	<input type="checkbox"/>		<input type="checkbox"/>	<input type="checkbox"/>	<input type="checkbox"/>
					<input type="checkbox"/>	<input type="checkbox"/>	<input type="checkbox"/>		<input type="checkbox"/>	<input type="checkbox"/>	<input type="checkbox"/>
					<input type="checkbox"/>	<input type="checkbox"/>	<input type="checkbox"/>		<input type="checkbox"/>	<input type="checkbox"/>	<input type="checkbox"/>
					<input type="checkbox"/>	<input type="checkbox"/>	<input type="checkbox"/>		<input type="checkbox"/>	<input type="checkbox"/>	<input type="checkbox"/>
					<input type="checkbox"/>	<input type="checkbox"/>	<input type="checkbox"/>		<input type="checkbox"/>	<input type="checkbox"/>	<input type="checkbox"/>
					<input type="checkbox"/>	<input type="checkbox"/>	<input type="checkbox"/>		<input type="checkbox"/>	<input type="checkbox"/>	<input type="checkbox"/>
					<input type="checkbox"/>	<input type="checkbox"/>	<input type="checkbox"/>		<input type="checkbox"/>	<input type="checkbox"/>	<input type="checkbox"/>
					<input type="checkbox"/>	<input type="checkbox"/>	<input type="checkbox"/>		<input type="checkbox"/>	<input type="checkbox"/>	<input type="checkbox"/>
					<input type="checkbox"/>	<input type="checkbox"/>	<input type="checkbox"/>		<input type="checkbox"/>	<input type="checkbox"/>	<input type="checkbox"/>
					<input type="checkbox"/>	<input type="checkbox"/>	<input type="checkbox"/>		<input type="checkbox"/>	<input type="checkbox"/>	<input type="checkbox"/>
					<input type="checkbox"/>	<input type="checkbox"/>	<input type="checkbox"/>		<input type="checkbox"/>	<input type="checkbox"/>	<input type="checkbox"/>

(\*) FOR REFERENCES & PRICES IF YOU ORDER IN-BETWEEN SIZES THE HIGHER PRICE APPLIES  
NOTE: FOR DOUBLE CORDING SYSTEM ADD 10%.

POSSIBLE ALUMINIUM TRACKS TYPES AND MODALITIES	STANDARS COMPONENTS			
	A	B	C	D
1.- Profile 7247				
2.- Profile 910 corded				
3.- Profile 910 uncorded (face/top-fix bracket)				
4.- Profile 910 uncorded (top-fix bracket)				
5.- Profile 950 corded				
6.- Profile 950 uncorded				
7.- Double profile 7288 uncorded				
8.- Double profile 7269 uncorded				
9.- Triple profile 1129 uncorded				
10.- Triple profile 1078				

Quantity: Brackets:  
 - To 1.00 m.: 2 units.  
 - Between 1.01 and 2.00 m.: 3 units.  
 - Between 2.01 and 3.50 m.: 4 units.  
 - More than 3.51 m.: 5 units.

(1) Standar cord fall: 1.75 m.  
 1 Simple runner per 10 cm. of track.

EVERY ADDITIONAL COMPONENTS WILL BE INVOICE BY PRICE LIST

Additional information:



Polígono Industrial "El Forseguer" s/n  
03460 BENEIXAMA (Alicante)

902 411 111  
FAX 902 411 110

Web: <http://www.rielchyc.com>  
E-mail: [rielchyc@rielchyc.com](mailto:rielchyc@rielchyc.com)

## HOJA DE PEDIDO - RIEL ALUMINIO

Fecha:  Código Cliente:

Cliente:

Dirección de envío:

Población:  C.P.:

Teléfono de contacto:  FAX:

ATENCIÓN AL CLIENTE: 902 411 111

FAX para PEDIDOS: 902 411 110

e-mail: [rielchyc@rielchyc.com](mailto:rielchyc@rielchyc.com)

REFERENCIA (*)	UNDS.	LONGITUD TOTAL DEL RIEL EN CM.	TIPO DE RIEL		MANDO				RECOGIDA		
			TIPO	MODALIDAD	IZQUIERDA	DERECHA	DOBLE	CAÍDA(CM) (1)	IZDA.	DCHA.	SIMETR.
					<input type="checkbox"/>	<input type="checkbox"/>	<input type="checkbox"/>		<input type="checkbox"/>	<input type="checkbox"/>	<input type="checkbox"/>
					<input type="checkbox"/>	<input type="checkbox"/>	<input type="checkbox"/>		<input type="checkbox"/>	<input type="checkbox"/>	<input type="checkbox"/>
					<input type="checkbox"/>	<input type="checkbox"/>	<input type="checkbox"/>		<input type="checkbox"/>	<input type="checkbox"/>	<input type="checkbox"/>
					<input type="checkbox"/>	<input type="checkbox"/>	<input type="checkbox"/>		<input type="checkbox"/>	<input type="checkbox"/>	<input type="checkbox"/>
					<input type="checkbox"/>	<input type="checkbox"/>	<input type="checkbox"/>		<input type="checkbox"/>	<input type="checkbox"/>	<input type="checkbox"/>
					<input type="checkbox"/>	<input type="checkbox"/>	<input type="checkbox"/>		<input type="checkbox"/>	<input type="checkbox"/>	<input type="checkbox"/>
					<input type="checkbox"/>	<input type="checkbox"/>	<input type="checkbox"/>		<input type="checkbox"/>	<input type="checkbox"/>	<input type="checkbox"/>
					<input type="checkbox"/>	<input type="checkbox"/>	<input type="checkbox"/>		<input type="checkbox"/>	<input type="checkbox"/>	<input type="checkbox"/>
					<input type="checkbox"/>	<input type="checkbox"/>	<input type="checkbox"/>		<input type="checkbox"/>	<input type="checkbox"/>	<input type="checkbox"/>
					<input type="checkbox"/>	<input type="checkbox"/>	<input type="checkbox"/>		<input type="checkbox"/>	<input type="checkbox"/>	<input type="checkbox"/>
					<input type="checkbox"/>	<input type="checkbox"/>	<input type="checkbox"/>		<input type="checkbox"/>	<input type="checkbox"/>	<input type="checkbox"/>
					<input type="checkbox"/>	<input type="checkbox"/>	<input type="checkbox"/>		<input type="checkbox"/>	<input type="checkbox"/>	<input type="checkbox"/>
					<input type="checkbox"/>	<input type="checkbox"/>	<input type="checkbox"/>		<input type="checkbox"/>	<input type="checkbox"/>	<input type="checkbox"/>
					<input type="checkbox"/>	<input type="checkbox"/>	<input type="checkbox"/>		<input type="checkbox"/>	<input type="checkbox"/>	<input type="checkbox"/>

(\*) CUANDO SE PIDAN MEDIDAS INTERMEDIAS A LAS ESTÁNDAR; SE APLICARÁ LA REFERENCIA Y PRECIO DE LA INMEDIATA SUPERIOR  
El Doble mando conlleva un recargo en precio de un 10%

TIPOS DE RIELES y MODALIDADES POSIBLES	Componentes Estándar			
	A	B	C	D
1.- Perfil 7247				
2.- Perfil 910 con cordón				
3.- Perfil 910 sin cordón sop.pared				
4.- Perfil 910 sin cordón sop.techo				
5.- Perfil 950 con cordón				
6.- Perfil 950 sin cordón				
7.- Perfil Doble Estrecho sin cordón ( 7288 )				
8.- Perfil Doble ancho sin cordón ( 7269 )				
9.- Perfil Triple sin cordón ( 1129 )				
10.- Perfil Triple ( 1078 )				

Nº de soportes/estribos:

- Hasta 1,0 metros: 2 unidades
- Entre 1,01 y 2,00: 3 unidades
- Entre 2,01 y 3,50: 4 unidades
- Más de 3,51 metros: 5 unidades

(1) Caída del cordón estándar: 1,75 metros.  
1 corredera simple por cada 10 cm. de riel

**Todos los componentes adicionales se facturarán a precio de tarifa.**

### Datos adicionales



Poligono Industrial "El Forseguer" s/n  
03460 BENEIXAMA (Alicante)  
☎ 902 411 111  
FAX 902 411 110  
Web: <http://www.rielchyc.com>  
E-mail: [rielchyc@rielchyc.com](mailto:rielchyc@rielchyc.com)

## ORDER FORM - UNDULATING SYSTEM CURTAIN

Date:  Código Cliente:   
Customer:   
Delivery address:   
Town:  Post code:   
Contact phone number:  Fax:

CONTACT US: 902 411 111

FAX for ORDER: 902 411 110

e-mail: [rielchyc@rielchyc.com](mailto:rielchyc@rielchyc.com)

REFERENCE	QTY.	TOTAL WIDTH CM.	COLOUR	SPACER		SYSTEM			STACKING WAYS			"UNDULATING" TAPE (See table)	
				9 CM.	6 CM.	LEFT	RIGHT	CAÍDA(CM) (1)	LEFT	RIGHT	CENTRE	NO	YES (QUANTITY)
				<input type="checkbox"/>	<input type="checkbox"/>	<input type="checkbox"/>	<input type="checkbox"/>		<input type="checkbox"/>	<input type="checkbox"/>	<input type="checkbox"/>	<input type="checkbox"/>	
				<input type="checkbox"/>	<input type="checkbox"/>	<input type="checkbox"/>	<input type="checkbox"/>		<input type="checkbox"/>	<input type="checkbox"/>	<input type="checkbox"/>	<input type="checkbox"/>	
				<input type="checkbox"/>	<input type="checkbox"/>	<input type="checkbox"/>	<input type="checkbox"/>		<input type="checkbox"/>	<input type="checkbox"/>	<input type="checkbox"/>	<input type="checkbox"/>	
				<input type="checkbox"/>	<input type="checkbox"/>	<input type="checkbox"/>	<input type="checkbox"/>		<input type="checkbox"/>	<input type="checkbox"/>	<input type="checkbox"/>	<input type="checkbox"/>	
				<input type="checkbox"/>	<input type="checkbox"/>	<input type="checkbox"/>	<input type="checkbox"/>		<input type="checkbox"/>	<input type="checkbox"/>	<input type="checkbox"/>	<input type="checkbox"/>	
				<input type="checkbox"/>	<input type="checkbox"/>	<input type="checkbox"/>	<input type="checkbox"/>		<input type="checkbox"/>	<input type="checkbox"/>	<input type="checkbox"/>	<input type="checkbox"/>	
				<input type="checkbox"/>	<input type="checkbox"/>	<input type="checkbox"/>	<input type="checkbox"/>		<input type="checkbox"/>	<input type="checkbox"/>	<input type="checkbox"/>	<input type="checkbox"/>	
				<input type="checkbox"/>	<input type="checkbox"/>	<input type="checkbox"/>	<input type="checkbox"/>		<input type="checkbox"/>	<input type="checkbox"/>	<input type="checkbox"/>	<input type="checkbox"/>	



### Quantity. Brackets:

- To 1,0 m.: 2 unites
- Between 1,01 & 2,00 m.: 3 unites
- Between 2,01 & 3,50 m.: 4 unites
- More than 3,51 m.: 5 unites

(1) Standard cord fall: 2,20 m.

To additional components, pleas specify in Additional information.

**Every additional components will be invoice by price list**

CORTITEX 75/2 	Nº POCKETS		RAPPORT	
			SPACING 6 cm.	SPACING 9 cm.
REF.: 0256201	6	A = 9,5 cm.	1,5 / 1	-
	8	A = 13 cm.	2 / 1	-
	8	A = 13 cm.	-	1,5 / 1
	10	A = 15,5 cm.	-	2 / 1

### Additional information





Polígono Industrial "El Forseguer" s/n  
03460 BÈNEIXAMA (Alicante)

902 411 111  
FAX 902 411 110

Web: <http://www.rielchyc.com>  
E-mail: [rielchyc@rielchyc.com](mailto:rielchyc@rielchyc.com)

## HOJA DE PEDIDO - RIEL ONDAS

Fecha:  Código Cliente:

Cliente:

Dirección de envío:

Población:  C.P.:

Teléfono de contacto:  FAX:

ATENCIÓN AL CLIENTE: 902 411 111

FAX para PEDIDOS: 902 411 110

e-mail: [rielchyc@rielchyc.com](mailto:rielchyc@rielchyc.com)

REFERENCIA	CANT.	LONGITUD TOTAL EN CM.	COLOR	DISTANCIADOR		MANDO CORDÓN			RECOGIDA			CINTA ONDAS (Ver TABLA)	
				9 CM.	6 CM.	IZQ.	DCHA.	CAÍDA(CM) (1)	IZDA.	DCHA.	SIMETR.	NO	SI (INDICAR CANTIDAD)
				<input type="checkbox"/>	<input type="checkbox"/>	<input type="checkbox"/>	<input type="checkbox"/>		<input type="checkbox"/>	<input type="checkbox"/>	<input type="checkbox"/>	<input type="checkbox"/>	
				<input type="checkbox"/>	<input type="checkbox"/>	<input type="checkbox"/>	<input type="checkbox"/>		<input type="checkbox"/>	<input type="checkbox"/>	<input type="checkbox"/>	<input type="checkbox"/>	
				<input type="checkbox"/>	<input type="checkbox"/>	<input type="checkbox"/>	<input type="checkbox"/>		<input type="checkbox"/>	<input type="checkbox"/>	<input type="checkbox"/>	<input type="checkbox"/>	
				<input type="checkbox"/>	<input type="checkbox"/>	<input type="checkbox"/>	<input type="checkbox"/>		<input type="checkbox"/>	<input type="checkbox"/>	<input type="checkbox"/>	<input type="checkbox"/>	
				<input type="checkbox"/>	<input type="checkbox"/>	<input type="checkbox"/>	<input type="checkbox"/>		<input type="checkbox"/>	<input type="checkbox"/>	<input type="checkbox"/>	<input type="checkbox"/>	
				<input type="checkbox"/>	<input type="checkbox"/>	<input type="checkbox"/>	<input type="checkbox"/>		<input type="checkbox"/>	<input type="checkbox"/>	<input type="checkbox"/>	<input type="checkbox"/>	
				<input type="checkbox"/>	<input type="checkbox"/>	<input type="checkbox"/>	<input type="checkbox"/>		<input type="checkbox"/>	<input type="checkbox"/>	<input type="checkbox"/>	<input type="checkbox"/>	
				<input type="checkbox"/>	<input type="checkbox"/>	<input type="checkbox"/>	<input type="checkbox"/>		<input type="checkbox"/>	<input type="checkbox"/>	<input type="checkbox"/>	<input type="checkbox"/>	

Nº de Soportes:

- Hasta 1,0 metro: 2 unidades
- Entre 1,01 y 2,00: 3 unidades
- Entre 2,01 y 3,50: 4 unidades
- Más de 3,51 metros: 5 unidades

(1) Caída del cordón estándar: 2,20 metros.

Cualquier otro componente adicional se reflejará en Observaciones.

**Todos los componentes adicionales se facturarán a precio de tarifa.**

<p>CORTITEX 75/2</p> <p>REF.: 0256201</p>	Nº BOLSAS		RAPPORT	
			DISTANCIADOR 6 cm.	DISTANCIADOR 9 cm.
	6	A = 9,5 cm.	1,5 / 1	-
	8	A = 13 cm.	2 / 1	-
	8	A = 13 cm.	-	1,5 / 1
10	A = 15,5 cm.	-	2 / 1	

Observaciones



**BUREAU VERITAS**  
Certification



## **Certificación** Certification

Concedida a / Awarded to

**RIEL CHYC SL**

PG IND EL FORSEGUER S/N  
03460 BENEIXAMA  
SPAIN

**Bureau Veritas certifica que el Sistema de Gestión ha sido auditado y encontrado conforme con los requisitos de la norma:**

Bureau Veritas certify that the Management System has been audited and found to be in accordance with the requirements of standard:

**NORMA / STANDARD**

**ISO 9001:2008**

**El Sistema de Gestión se aplica a:**

Scope of certification:

**DISEÑO, FABRICACIÓN Y COMERCIALIZACIÓN DE RIELES PARA CORTINAS.**

DESIGN, MANUFACTURE AND WHOLESSELLING OF CURTAIN FITMENTS

**Número del Certificado**  
Certificate Number

**ES042813-1**

Director General / General Manager  
Bureau Veritas Certification, S.A.

**Aprobación original :**  
Original approval date :

**27/10/2006**

**Certificado en vigor:**  
Effective date:

**08/07/2012**

**Caducidad del certificado:**  
Certificate expiration date:

**07/07/2015**

*Este certificado está sujeto a los términos y condiciones generales y particulares de los servicios de certificación*  
*This certificate is valid, subject to the general and specific terms and conditions of certification services*

Managing Office/ Oficina Central: Bureau Veritas Certification, S.A.  
Issuing Office Oficina de emisión: Bureau Veritas Certification, S.A.  
C/ Valportillo Primera 22-24, Edificio Caoba, Pol. Ind. La granja, 28108 Alcobendas Madrid

**ENAC**  
CERTIFICACIÓN  
Nº 04/C-SC004



## COMMERCIAL INTERNATIONAL MANAGEMENT

---

**RIEL CHYC, S.L.**

Polígono Industrial "El Forseguer" s/n

03460 BENEIXAMA (Alicante)

Tel.: 902 411 111 / 618 653 744

Fax: 902 411 110

[www.rielchyc.com](http://www.rielchyc.com)

[rielchyc@rielchyc.com](mailto:rielchyc@rielchyc.com)



Polígono Industrial "El Forseguer" s/n  
03460 BENEIXAMA (Alicante)  
Tel.: 902 411 111 Fax: 902 411 110  
[www.rielchyc.com](http://www.rielchyc.com)  
[rielchyc@rielchyc.com](mailto:rielchyc@rielchyc.com)



Portela das Maunças, GUERREIROS  
2670 - 556 LOURES (Portugal)  
Tel.: 00 351 219 835 871 / 00 351 219 835 921  
Fax: 00 351 219 835 377  
[www.rielchyc.com](http://www.rielchyc.com)  
[calhas-chyc@rielchyc.com](mailto:calhas-chyc@rielchyc.com)



ZAC NATUROPOLE 9 rue Gustave Eiffel  
66350 TOULOUGES (FRANCE)  
Tel.: 00 33 468 54 09 88 (3 lignes)  
Fax. 00 33 468 55 56 90  
[www.rielchyc.com/fr](http://www.rielchyc.com/fr)  
[rielchyc-france@rielchyc.com](mailto:rielchyc-france@rielchyc.com)



Unit 9B/C/D Stonehill Bussiness Park  
Silvermere Drive, Edmonton  
London N18 3QH, United Kingdom  
Tel.: 00 44 20 8807 7272 Fax: 00 44 20 8807 7217  
[www.rielchyc.com](http://www.rielchyc.com)  
[rielchyc-uk@rielchyc.com](mailto:rielchyc-uk@rielchyc.com)





